

**EN** Installation manual / **DE** Montageanleitung / **ES** Manual de montaje /  
**FR** Notice de montage / **IT** Istruzioni di montaggio / **PL** Instrukcja montażu /  
**RU** инструкция по монтажу

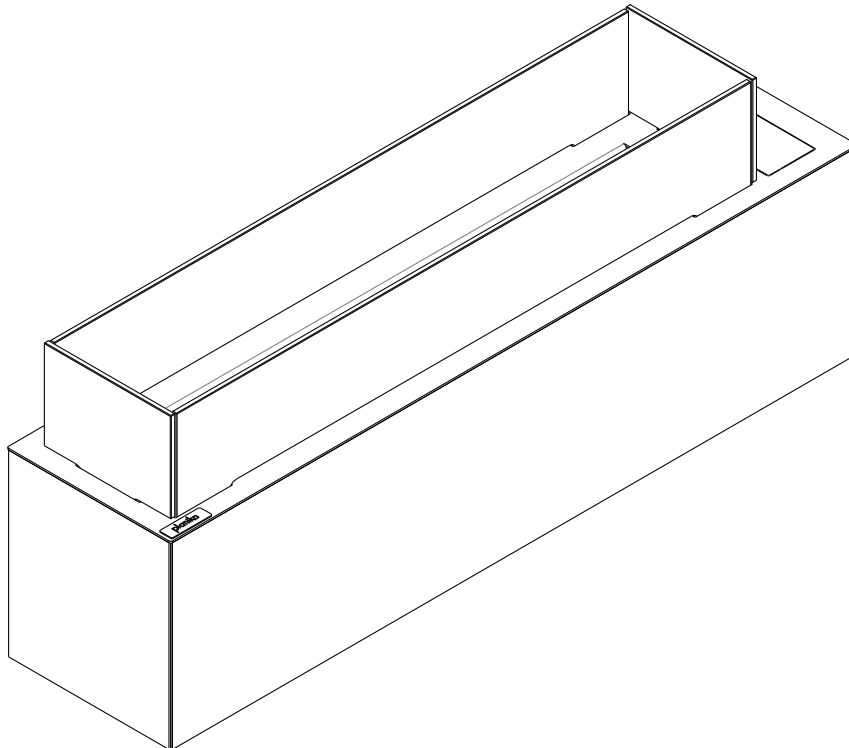

## **WARNING / WARNUNG / ADVERTENCIA / AVERTISSEMENT / ATTENZIONE / OSTRZEŻENIE / ВНИМАНИЕ**

**EN** This manual only applies to the installation and operation of Cabo Fireplace only. The installation of the Cabo Burner is included in the other manual.

**DE** Diese Anleitung gilt nur für die Installation und den Betrieb von Cabo Fireplace. Die Installation des Cabo Burner ist in der anderen Anleitung enthalten.

**ES** Este manual sólo se aplica a la instalación y funcionamiento de Cabo Fireplace únicamente. La instalación del Cabo Burner se incluye en el otro manual.

**FR** Ce manuel ne s'applique qu'à l'installation et à l'utilisation de Cabo Fireplace uniquement. L'installation du Cabo Burner fait l'objet d'un autre manuel.

**IT** Il presente manuale si applica esclusivamente all'installazione e al funzionamento di Cabo Fireplace. L'installazione del Cabo Burner è inclusa nell'altro manuale.

**PL** Niniejsza instrukcja dotyczy wyłącznie instalacji i obsługi palnika Cabo Table Instalacja Cabo Fireplace zawarta jest w innej instrukcji.

**RU** Данное руководство относится только к установке и эксплуатации Только для камина Cabo Fireplace. Установка Cabo Burner включена в другое руководство..

EN	INSTALLATION MANUAL .....	6
DE	MONTAGEANLEITUNG .....	6
ES	MANUAL DE MONTAJE.....	6
FR	NOTICE DE MONTAGE .....	6
IT	ISTRUZIONI DI MONTAGGIO .....	6
PL	INSTRUKCJA MONTAŻU.....	6
RU	ИНСТРУКЦИЯ ПО МОНТАЖУ .....	6
EN	INSTRUCTION MANUAL .....	10
DE	BEDIENUNGSANLEITUNG .....	15
ES	MANUAL DE USUARIO.....	19
FR	NOTICE D'UTILISATION .....	25
IT	MANUALE D'USO .....	30
PL	INSTRUKCJA OBSŁUGI .....	35
RU	ИНСТРУКЦИЯ ПО ЭКСПЛУАТАЦИИ .....	40



**The product is a decorative device with real fire.**

**Read the included documentation prior to installing and operating the device.**

**Check the local regulations for fireplaces.**

1. For outdoor and indoor use. Min. temperature of use is 0°C.
2. Room cubature for one device – min. 94 m<sup>3</sup> (in case of indoor installations)
3. Natural air exchange rate in room – min. 1/h. (in case of indoor installations)
4. Do not cover top ventilation openings of the device.
5. Do not place any objects on the top of the device.
6. We recommend placing a CO<sub>2</sub> or dry powder fire extinguisher nearby the device
7. For service purposes, the surrounding must allow for easy removal of the device.
8. Keep children, animals and unauthorized persons away from the device.
9. Keep the packaging and manuals for future use.
10. Do not turn on the device in case of fuel spill.
11. Do not interfere in the fuel filler when the device is operating.
12. Do not interfere in the device construction.
13. Do not touch the filament and other hot elements.
14. Do not transport the device if fueled.
15. Do not leave an operating device unattended
16. The Cosentino Silestone Gris is a natural material which, when exposed to UV rays for very long periods of time, may slightly change shade. When not in use, we recommend covering the product with a cover designed for this product.



**Es ist ein Dekorationsprodukt und es brennt mit echtem Feuer. Vor der Montage und vor der Inbetriebnahme des Kamins lesen Sie bitte die beigelegte Dokumentation. Machen Sie sich mit den lokalen Vorschriften bezüglich der Kamine vertraut.**

1. Nur für den Außen- und Innenbereich. Die Mindesttemperatur für die Verwendung beträgt 0°C.
2. Rauminhalt für ein Gerät - min. 94 m<sup>3</sup> (bei Inneninstallationen)
3. Natürliche Luftwechselrate im Raum - min. 1/h. (im Falle von Inneninstallationen)
4. Die Lüftungsschlitze nicht zudecken.
5. Keine Gegenstände auf dem Kamin platzieren.
6. Wir empfehlen, einen CO<sub>2</sub>- oder Trockenpulver-Feuerlöscher in der Nähe des Geräts aufzustellen
7. Die Montage des Kamins muss eine problemlose Herausnahme zu Wartungszwecken ermöglichen.
8. Den Kamin an einem für Kinder, Unbefugte und Tiere unzugänglichen Ort installieren.
9. Verpackung und Gebrauchsanweisung aufbewahren.
10. Im Falle des Brennstoffauslaufs, das Gerät nicht einschalten
11. Falls der Kamin im Betrieb ist, die Einfüllöffnung nicht berühren
12. In die Konstruktion des Gerätes nicht eingreifen
13. Das Glühelement und andere warmen Elemente nicht berühren
14. Den, mit Brennstoff nachgefüllten Kamin nicht transportieren
15. Das Gerät im Betrieb nicht ohne Aufsicht lasse
16. Der Cosentino Silestone Gris ist ein natürliches Material, das bei längerer Einwirkung von UV-Strahlen seinen Farbton leicht verändern kann. Wir empfehlen, das Produkt bei Nichtgebrauch mit einer für dieses Produkt geeigneten Abdeckung zu versehen.



**El producto es un dispositivo decorativo que produce fuego real. Familiarícese con la documentación adjunta antes de instalar e iniciar el dispositivo. Familiarícese con las regulaciones locales sobre chimeneas.**

1. Sólo para uso exterior e interior. La temperatura mínima de uso es de 0°C.
2. Cubicación del local para un aparato - mín. 94 m<sup>3</sup> (en caso de instalaciones interiores)
3. Tasa de intercambio de aire natural en la habitación - mín. 1/h. (en caso de instalaciones interiores)
4. No cubra las ranuras de ventilación.
5. Está prohibido colocar objetos en el dispositivo.
6. Se recomienda colocar un extintor de polvo o CO<sub>2</sub> cerca del dispositivo.
7. La instalación del dispositivo debe permitir una extracción fácil para el mantenimiento.
8. El dispositivo debe estar protegido contra el acceso de niños, animales y personas no autorizadas.
9. Guarde el embalaje y las instrucciones.
10. No encienda el dispositivo si el combustible se derrama fuera del tanque.
11. No toque el llenador de combustible cuando el dispositivo esté funcionando.
12. No modifique la construcción del dispositivo.
13. No toque el filamento o las partes calientes.
14. No transporte el dispositivo con combustible.
15. No deje el dispositivo funcionando sin supervisión
16. El Cosentino Silestone Gris es un material natural que, expuesto a los rayos UV durante periodos de tiempo muy largos, puede cambiar ligeramente de tonalidad. Cuando no esté en uso, se recomienda cubrir el producto con una cubierta diseñada para este producto.



**Le produit est un dispositif décoratif qui produit un feu réel. Familiarisez-vous avec la documentation ci-jointe avant d'installer et de démarrer l'appareil. Familiarisez-vous avec les réglementations locales concernant les cheminées.**

1. Pour une utilisation à l'extérieur et à l'intérieur. La température minimale d'utilisation est de 0°C.
2. Cubature de la pièce pour un appareil - min. 94 m<sup>3</sup> (dans le cas d'installations intérieures).
3. Taux de renouvellement de l'air naturel dans la pièce - min. 1/h. (dans le cas d'installations intérieures)
4. Ne couvrez pas les fentes de ventilation.
5. Il est interdit de placer des objets sur l'appareil.
6. Il est recommandé de placer un extincteur à poudre ou à CO<sub>2</sub> à proximité de l'appareil.
7. L'installation de l'appareil doit permettre un retrait facile pour l'entretien.
8. L'appareil doit être protégé contre l'accès des enfants, des animaux et des personnes non autorisées.
9. Conservez l'emballage et les instructions.
10. Ne démarrez pas l'appareil en cas de débordement
11. Ne touchez pas le lieu de remplissage de carburant lorsque l'appareil est en marche.
12. Ne modifiez pas la construction de l'appareil.
13. Ne touchez pas le filament ou les parties chaudes.
14. Ne transportez pas l'appareil avec du carburant.
15. Ne laissez pas l'appareil fonctionner sans surveillance
16. Le Cosentino Silestone Gris est un matériau naturel qui, lorsqu'il est exposé aux rayons UV pendant de très longues périodes, peut changer légèrement de teinte. Lorsque le produit n'est pas utilisé, il est recommandé de le recouvrir d'une housse conçue pour ce produit.



**Prodotto è un dispositivo decorativo che produce un vero fuoco. Familiarizzare con il manuale allegato prima di installare e avviare il dispositivo. Familiarizzare con le normative locali relative ai camini.**

1. Solo per uso esterno e interno. La temperatura minima di utilizzo è 0°C.
2. Cubatura del locale per un dispositivo - min. 94 m<sup>3</sup> (in caso di installazioni interne).
3. Tasso di ricambio d'aria naturale nella stanza - min. 1/h. (in caso di installazioni interne)
4. Non coprire le fessure di ventilazione.
5. È vietato posizionare oggetti sul dispositivo.
6. Si consiglia di posizionare un estintore a polvere o ad anidride carbonica vicino all'unità.
7. L'installazione del dispositivo deve consentire una facile rimozione per un eventuale manutenzione.
8. Il dispositivo deve essere protetto dall'accesso di bambini, animali e persone non autorizzate.
9. Conservare la confezione originale e le istruzioni d'uso.
10. Non avviare il dispositivo nel caso di fuoriuscita di carburante dal serbatoio.
11. Non operare nei pressi di bocchettone di riempimento quando il dispositivo è in funzione.
12. Non interferire nella costruzione del dispositivo.
13. Non toccare la resistenza o le parti calde del dispositivo.
14. Non trasportare il dispositivo con carburante.
15. Non lasciare incustodito il dispositivo.
16. Il Cosentino Silestone Gris è un materiale naturale che, se esposto ai raggi UV per periodi di tempo molto lunghi, può cambiare leggermente tonalità. Quando non viene utilizzato, si consiglia di coprirlo con un telo apposito per questo prodotto.



**Produkt jest urządzeniem dekoracyjnym wytwarzającym prawdziwy ogień. Zapoznaj się z załączoną dokumentacją przed montażem i uruchomieniem urządzenia. Zapoznaj się z lokalnymi przepisami dotyczącymi kominków**

1. Urządzenie wyłącznie do użytku zewnętrznego wewnętrznego. Używać w temperaturze min. 0°C.
2. Kubatura pomieszczenia dla jednego urządzenia - min. 94 m<sup>3</sup>(dla instalacji wewnątrz)
3. Naturalna wymiana powietrza w pomieszczeniu - min. 1/h. (dla instalacji wewnątrz)
4. Nie zakrywać otworów wentylacyjnych urządzenia.
5. Zabrania się umieszczania jakichkolwiek przedmiotów na urządzeniu.
6. Zaleca się umieszczenie w pobliżu urządzenia gaśnicy proszkowej lub CO<sub>2</sub>.
7. Montaż urządzenia musi umożliwić bezproblemowe wyjęcie go w celu serwisowania.
8. Urządzenie należy zabezpieczyć przed dostępem dzieci, zwierząt oraz osób niepowołanych.
9. Należy zachować opakowanie oraz instrukcje.
10. Nie uruchamiaj urządzenia w przypadku rozlania paliwa poza zbiornik.
11. Nie operuj przy wlewie paliwa, gdy urządzenie jest uruchomione.
12. Nie ingeruj w konstrukcję urządzenia.
13. Nie dotykaj żarnika oraz rozgrzanych elementów.
14. Nie transportuj urządzenia z paliwem.
15. Nie pozostawiaj uruchomionego urządzenia bez nadzoru.
16. Cosentino Silestone Gris to naturalny materiał, który pod wpływem działania promieni UV przez bardzo długi czas może nieznacznie zmienić odcień. Gdy nie jest używany, zalecamy przykrycie go pokrowcem przeznaczonym do tego produktu.



**Продукт является декоративным изделием, производящим настоящий огонь. Ознакомьтесь с приложенной документацией перед монтажом и запуском устройства. Ознакомьтесь с местными правилами, касающимися каминов**

1. Только для использования на улице и в помещении. Минимальная температура использования - 0°C.
2. Кубатура помещения для одного устройства - мин. 94 м<sup>3</sup> (при установке в помещении).
3. Естественный воздухообмен в помещении - мин. 1/ч. (при установке в помещении)
4. Не закрывать вентиляционных щелей на устройстве.
5. Запрещается размещать на устройстве любые предметы.
6. Рядом с устройством рекомендуется размещать порошковый или углекислотный огнетушитель.
7. Устройство должно быть установлено таким образом, чтобы его легко можно было извлечь для сервиса.
8. Устройство должно быть защищено от детей, животных и посторонних лиц.
9. Необходимо сохранить оригинальную упаковку устройства, а также настоящую инструкцию.
10. Не включать устройства в случае утечки топлива из бака.
11. Не заправлять камин топливом, когда устройство работает.
12. Не вмешиваться в конструкцию устройства.
13. Не трогать нити накаливания и горячих элементов.
14. Нельзя перемещать устройство, наполненное топливом.
15. Не оставлять запущенного устройства без присмотра
16. Cosentino Silestone Gris - это натуральный материал, который при длительном воздействии ультрафиолетовых лучей может слегка изменить оттенок. Когда изделие не используется, мы рекомендуем накрывать его чехлом, предназначенным для этого изделия.

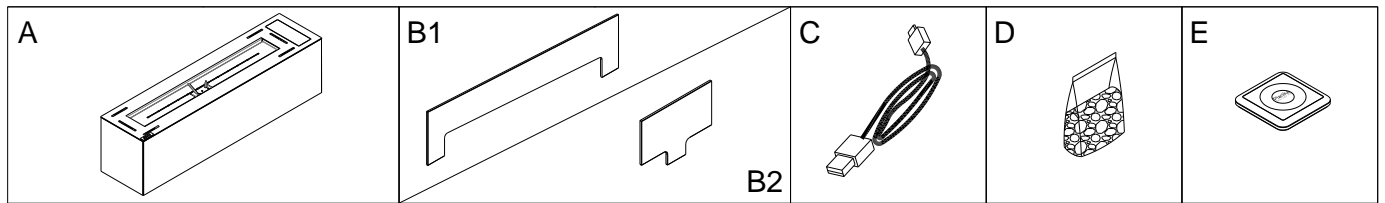
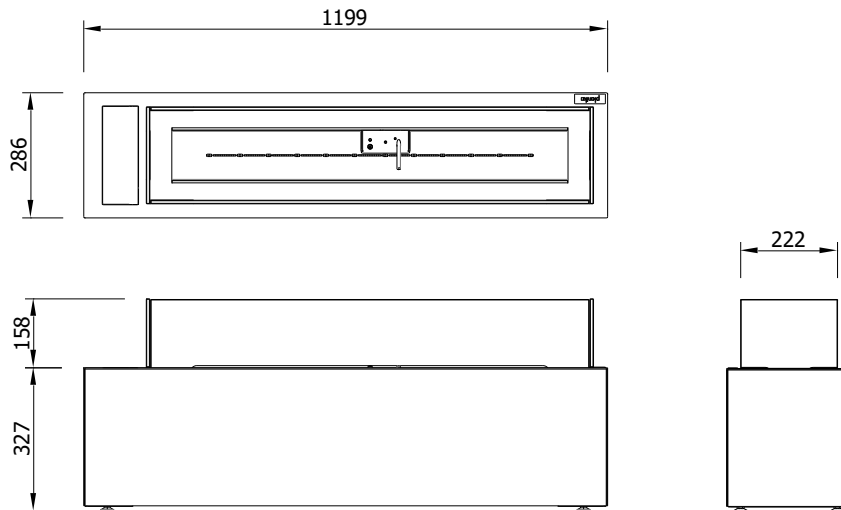

	EN	DE	ES	FR	IT	PL	RU	Quantity
A.	Firebox with burner	Feuerraum mit Brenner	Hogar con quemador	Foyer avec brûleur	Focolare con bruciatore	Obudowa z paleniskiem	Топка с горелкой	1
B.	Glass	Glas	Vidrio	Verre	Vetro	Szyba	Стекло	2+2
C.	Service cable	Service -Kabel	Cable USB de servicio	Câble de service	Cavetto per l'assistenza tecnica	Kabel serwisowy	кабель сервиса	1
D.	Bag with granules	Tasche mit dem Granulat	Bolsa de gránulos	sachet de granulés	Sacchetto per granuli	Torba z granulatem	Мешок с гранулами	5
E.	Remote control	Fernbedienung	Control remoto	Télécommande	Telecomando	Pilot	пульт дистанционного управления	1

EN	Install the glass panes of the appliance by placing them in the prepared holes. Level the fireplace and connect it to the mains using a waterproof socket.
DE	Montieren Sie die Glasscheiben des Geräts, indem Sie sie in die vorbereiteten Löcher einsetzen. Richten Sie den Kamin aus und schließen Sie ihn mit einer wasserdichten Steckdose an das Stromnetz an.
ES	Instale los cristales del aparato colocándolos en los orificios preparados. Nivele el hogar y conéctelo a la red eléctrica mediante una toma estanca.
FR	Installez les vitres de l'appareil en les plaçant dans les trous préparés. Mettez le foyer à niveau et raccordez-le au secteur à l'aide d'une prise étanche.
IT	Installare le lastre di vetro dell'apparecchio inserendole nei fori predisposti. Livellare il caminetto e collegarlo alla rete elettrica utilizzando una presa impermeabile.
PL	Zainstaluj szyby urządzenia umieszczając je w przygotowanych otworach. Wypoziomuj kominek i podłącz do sieci elektrycznej używając wodoszczelnego gniazda.
RU	Установите стеклянные стекла прибора, поместив их в подготовленные отверстия. Выровняйте камин и подключите его к электросети с помощью водонепроницаемой розетки.

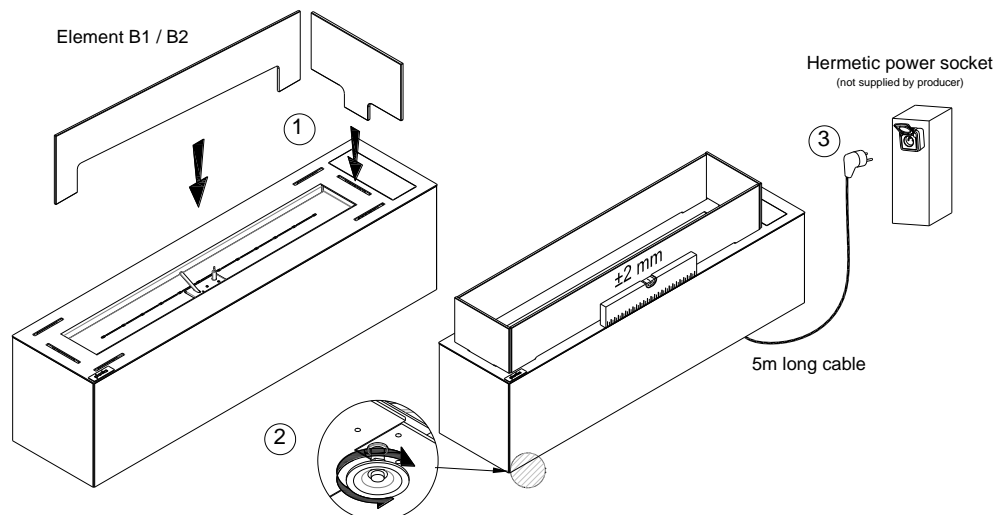

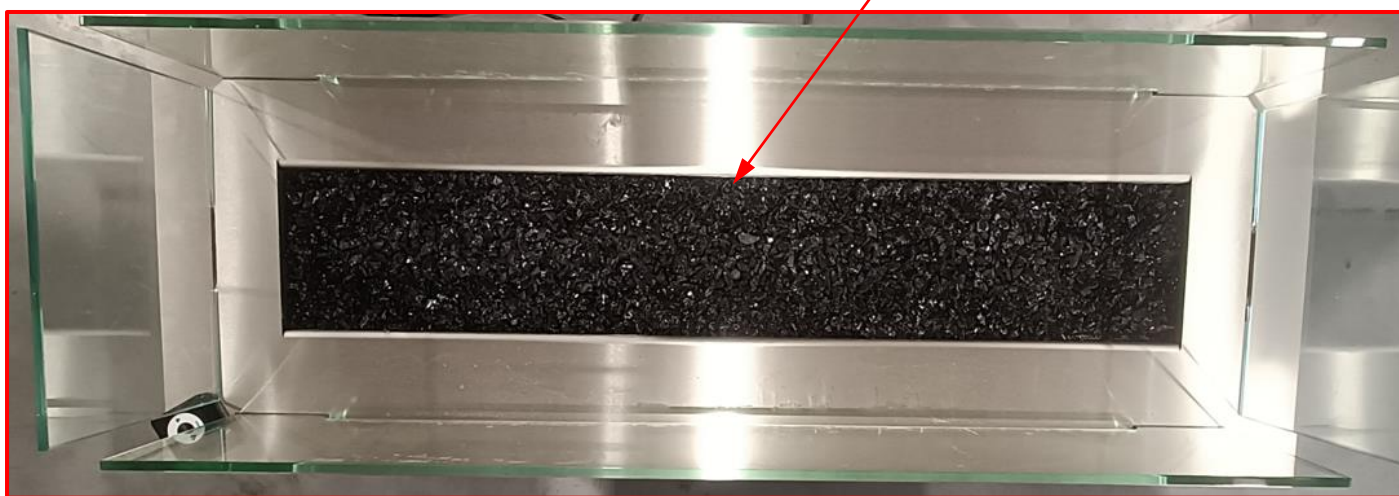
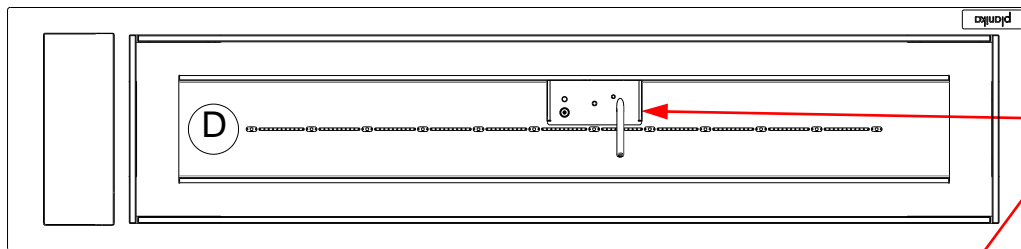

<b>EN</b>	Spread the granules (D) evenly on the marked area without leaving any free spaces. Ensure that the granules do not touch the filament.
<b>DE</b>	Verteilen Sie das Granulat (D) gleichmäßig auf der markierten Fläche, ohne Freiräume zu lassen. Achten Sie darauf, dass das Granulat den Faden nicht berührt.
<b>ES</b>	Esparza los gránulos (D) uniformemente sobre la zona marcada sin dejar espacios libres. Asegúrese de que los gránulos no toquen el filamento.
<b>FR</b>	Répartissez les granulés (D) de manière homogène sur la zone marquée sans laisser d'espaces libres. Veillez à ce que les granulés ne touchent pas le filament.
<b>IT</b>	Distribuire i granuli (D) in modo uniforme sull'area contrassegnata, senza lasciare spazi liberi. Assicurarsi che i granuli non tocchino il filamento.
<b>PL</b>	Rozłóż równomiernie granulat (D) w oznaczonym miejscu nie zostawiając wolnych przestrzeni. Zwróć uwagę aby granulat nie dotykał żarnika.
<b>RU</b>	Равномерно распределите гранулы (D) на размеченном участке, не оставляя свободных мест. Убедитесь, что гранулы не касаются нити.

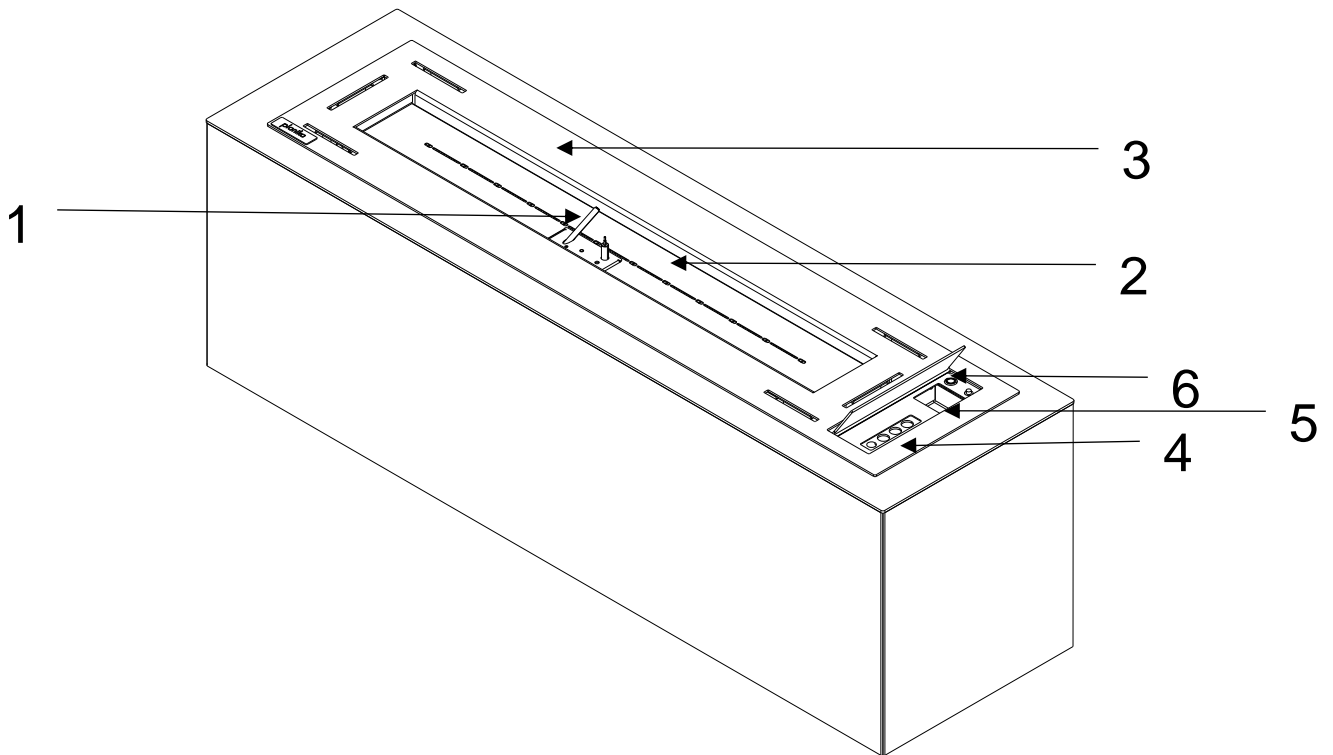

EN	DE	ES	FR
1. Filament	1. Glühelement	1. Filamento	1. Filament
2. Burner	2. Feuerungsleiste	2. Quemador	2. Foyer
3. Device surface	3. Feuerungsrost	3. Tapa de la chimenea	3. Brûleur
4. Control panel	4. Bedienpanel	4. Panel de control	4. Panneau de commande
5. Fuel hose	5. Kraftstoffschlauch	5. Manguera de combustible	5. Tuyau de carburant
6. Fuel pump button	6. Knopf der Kraftstoffpumpe	6. Botón de la bomba de combustible	6. Bouton de la pompe à carburant
IT	PL	RU	
1. Resistenza	1. Żarnik	1. нить накаливания	
2. Focolare	2. Palenisko	2. горелка	
3. Bruciatore	3. Ruszt	3. верхняя плита	
4. Pannello di controllo	4. Panel sterowania	4. панель управления	
5. Tubo flessibile del carburante	5. Przewód paliwowy	5. Топливный шланг	
6. Pulsante della pompa del carburante	6. Przycisk pompy paliwa	6. Кнопка топливного насоса	



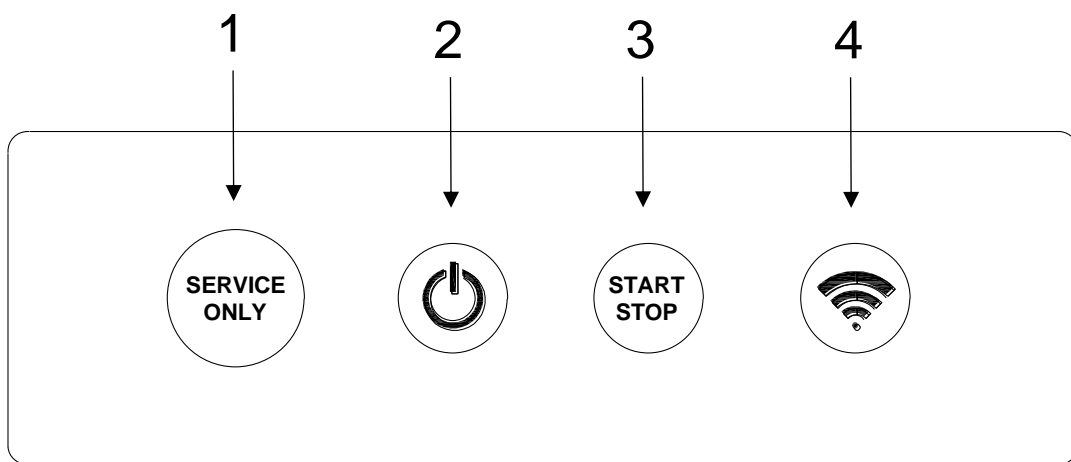

EN	DE	ES	FR
<ul style="list-style-type: none"> <li>1. Service port</li> <li>2. Power ON/OFF</li> <li>3. Flame START/STOP</li> <li>4. Wi-Fi configuration/status</li> </ul>	<ul style="list-style-type: none"> <li>1. Service-USB-Eingang</li> <li>2. Ein – und Ausschalten des Kamins</li> <li>3. Anzünden und Erlöschen der Flamme</li> <li>4. Konfiguration / WIFI Status</li> </ul>	<ul style="list-style-type: none"> <li>1. Puerto de servicio</li> <li>2. Iniciar / apagar el dispositivo</li> <li>3. Encender / apagar el dispositivo</li> <li>4. Configuración / estado de WIFI</li> </ul>	<ul style="list-style-type: none"> <li>1. Prise de service</li> <li>2. Allumer/éteindre l'appareil</li> <li>3. Allumer / éteindre la flamme</li> <li>4. Configuration/état WIFI</li> </ul>
IT	PL	RU	
<ul style="list-style-type: none"> <li>1. Presa USB</li> <li>2. Accensione/spengimento del dispositivo</li> <li>3. Accensione/spengimento della fiamma</li> <li>4. Configurazione/statuso WIFI</li> </ul>	<ul style="list-style-type: none"> <li>1. Gniazdo serwisowe</li> <li>2. Włączenie / wyłączenie urządzenia</li> <li>3. Odpalenie / wygaszanie płomienia</li> <li>4. Konfiguracja / status WIFI</li> </ul>	<ul style="list-style-type: none"> <li>1. Сервисный порт для подключения кабеля</li> <li>2. Включение / выключение устройства</li> <li>3. Розжиг / тушение пламени</li> <li>4. Конфигурация / статус WIFI</li> </ul>	

## REPLACING FUEL CONTAINER

1. Turn the device on by pressing .
2. If the fuel tank is empty (**START/STOP BUTTON BLUE LIGHT ON**), open the flap and pull out the fuel hose (I). Place the loose end in the fuel container and press and hold the fuel pump button (II).
3. If the tank fills up (**START/STOP BUTTON GREEN LIGHT ON**) put the fuel hose back in place. (III)

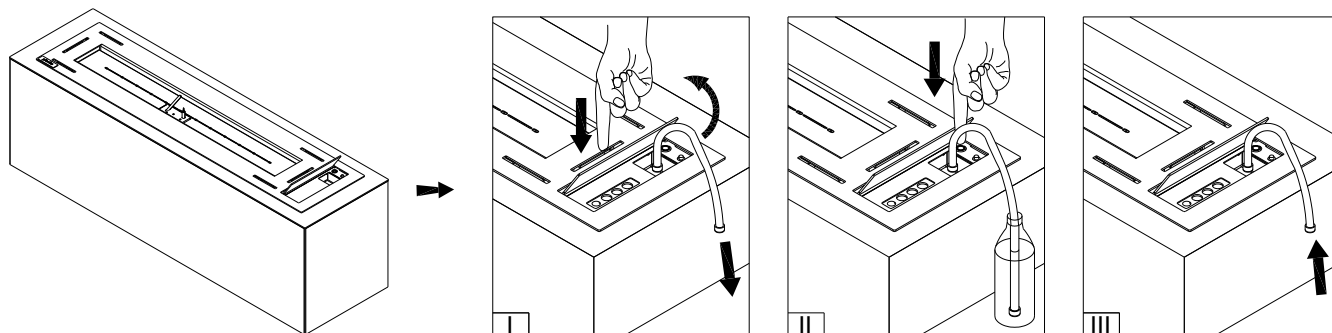



## FLAME IGNITION

When the **START/STOP** button is lit up in green, the device is ready to be launched.

Press **START**. Firing up of the device takes from 2 to 10 minutes (**FLASHING GREEN LIGHT**). During the process of firing up, scent of fumes can be present. When the lights stop flashing, the device is lit up and has reached the working temperature.

## FLAME HEIGHT REGULATION

When the flame is on, press the  or  button on the remote or scroll the flame level bar in the mobile app to choose one of the six flame heights. The flame starts on height 4 by default.

**NOTE.** In case of too high a temperature of the device, the flame height will be automatically decreased and locked from changing. If the temperature continues to increase, the flame will be extinguished (**RED LIGHT**)

## FLAME EXTINGUISHING

To extinguish the flame:

-press **STOP**.

**Flashing red light** indicated the device being cooled. Restarting the flame is possible only after complete cooldown of the device (**GREEN LIGHT**).







## TURNING THE DEVICE OFF

To turn the device OFF, press .

The device will automatically turn off in case of any work related errors. (check the error in the mobile app).

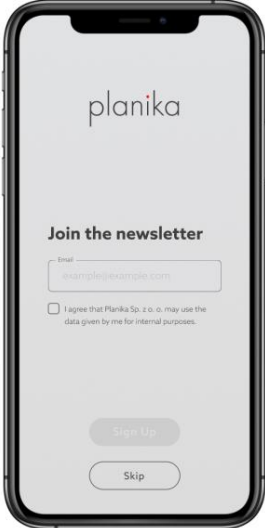
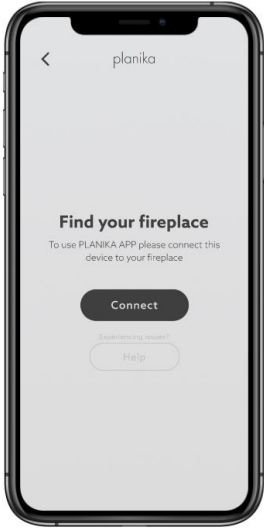
## WIRELESS CONTROL CONFIGURATION

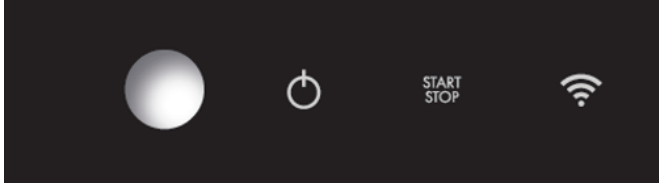
To pair the device with the mobile app (simultaneous pairing of more than one device is not possible):

<p><b>Join the newsletter</b></p> <p>1. Launch the <b>FLA3 NET-ZERO</b> mobile app. Join the newsletter by submitting your e-mail address and pressing <b>SIGN UP</b> or simply press <b>SKIP</b>.</p> <p style="text-align: center;"> <span>Google play</span>      <span>Appstore</span> </p> <div style="display: flex; justify-content: space-around;">   </div>		<p><b>Find your fireplace</b></p> <p>2. On the <b>FIND YOUR FIREPLACE</b> screen press <b>CONNECT</b> to start the network search.</p>	
<p>3. Press and hold the WiFi button  on the fireplace. When the button starts flashing, the fireplace is ready to be paired for 5 minutes.</p>			
			
<p><b>Setup Network Active</b></p> <p>4. Go to mobile device setup, turn on the WiFi network and connect with <b>Fireplace_WiFi_setup</b> (if the network is not visible, unplug the device for 10 seconds and retry the configuration). The fireplace will be automatically found by the mobile app, which will be confirmed by the app (<b>SETUP NETWORK ACTIVE</b>). Press <b>CONNECT</b>.</p>		<p><b>Connect to Home Network</b></p> <p>5. On the <b>CONNECT TO HOME NETWORK</b> screen, choose the name of the network which you plan to use by default (<b>NETWORK NAME</b>) and submit its password. Make sure the password is correct and hit (<b>SUBMIT</b>).</p>	

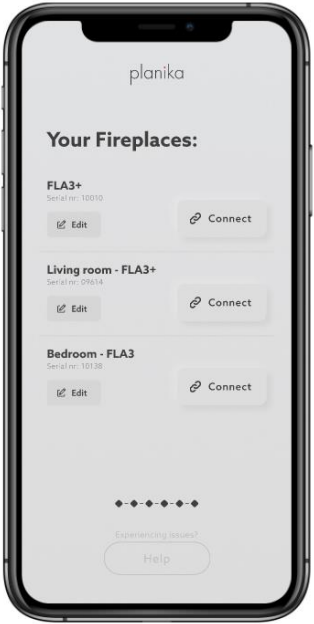
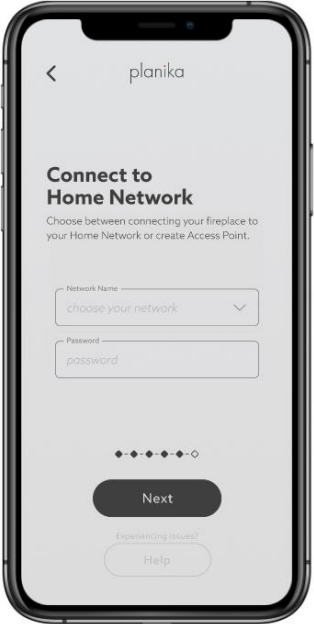

Your fireplaces		Access Point	
<p>6. On the following screen (<b>YOUR FIREPLACES</b>), choose your device and press <b>CONNECT</b>. The screen also allows you to change the name of the fireplace (<b>EDIT</b>).</p>		<p>7. You can also create a dedicated network <b>ACCESS POINT</b> and connect directly with the device. To do that, press (<b>HELP</b>), choose (<b>CONNECTION TYPE</b>), and (<b>ACCESS POINT</b>), then confirm by pressing (<b>CREATE ACCESS POINT</b>). Submit new name for the network and the password. Confirm by pressing <b>NEXT</b>.</p>	

After successful configuration, the WiFi button will light up in green.

**FLA3 NET-ZERO MOBILE APP**



	<ol style="list-style-type: none"> <li>1. Newsletter</li> <li>2. Fireplace status</li> <li>3. Flame height</li> <li>4. Start and stop</li> <li>5. Info</li> <li>6. Menu</li> </ol>
---	--

## MENU

To access menu, press the  button. To go back to the main panel, press **BACK** 

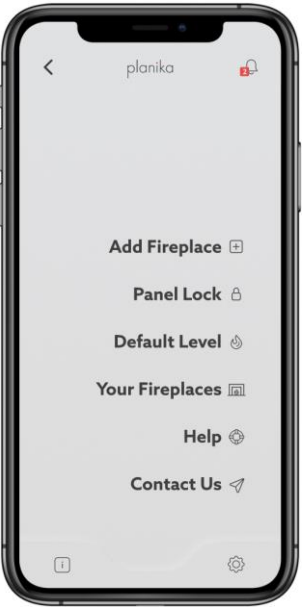
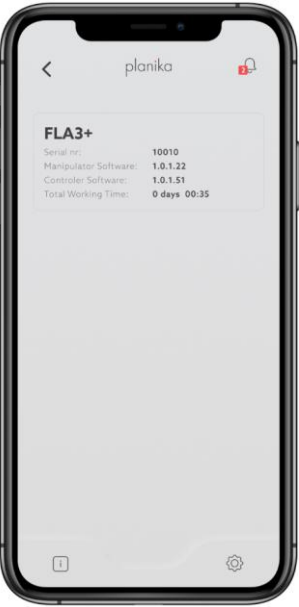
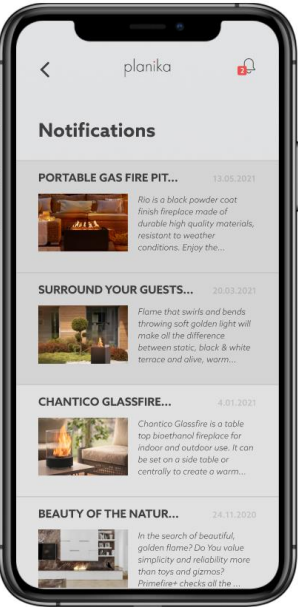
To access general information about the fireplace, press the  button. The newsletter is available after pressing the  button.

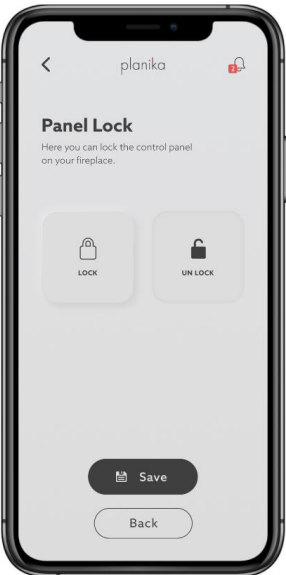

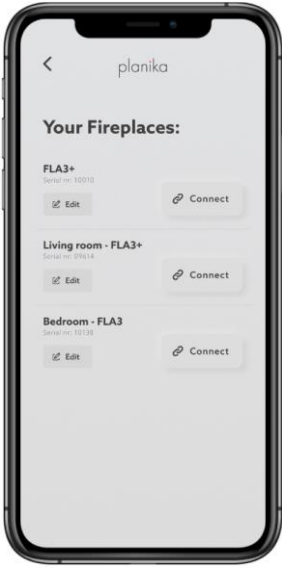
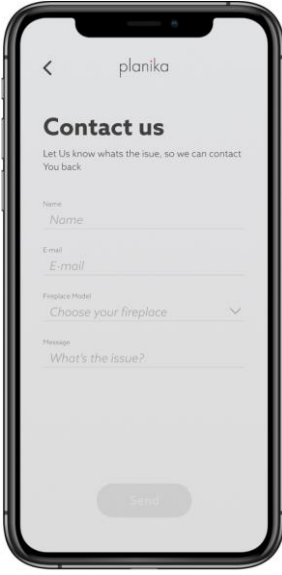



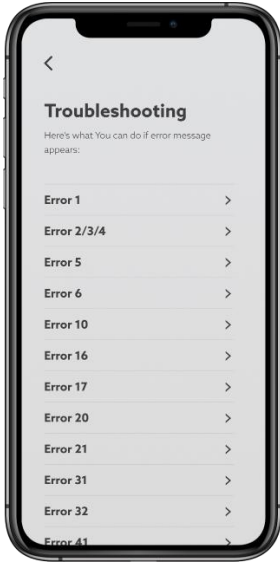
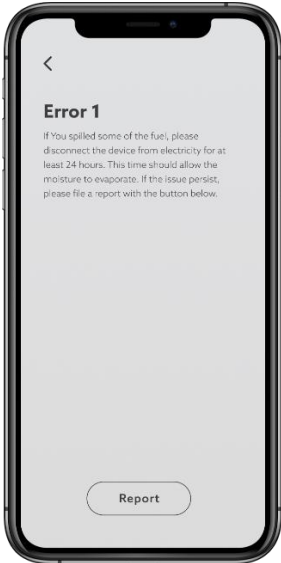
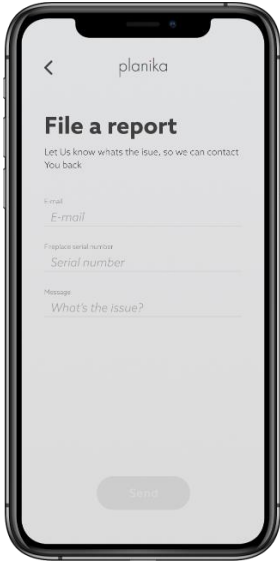







Menu	Info	Newsletter
		
<p>Main app setup. Press the tab to change the settings.</p>	<p>Press to check the general information of the fireplace</p>	<p>Press to check the notifications</p>

Panel Lock	Default Level	Your fireplaces	Contact us
			
<p>Press <b>LOCK</b> to lock the control panel on the fireplace. Press <b>UNLOCK</b> to unlock the control panel on the fireplace. Confirm by clicking <b>SAVE</b>. The change is possible with the fireplace off only.</p>	<p>Change the default launch flame height. Press <b>SAVE</b> to confirm the change. Press <b>RESET</b> to reset your choice. The default setting of the flame is height 4.</p>	<p>Check available fireplaces. Press <b>EDIT</b> to change the device name. Press <b>CONNECT</b> to connect to the device.</p>	<p>Contact Planika by e-mail. Press <b>SEND</b> to send us an e-mail.</p>

## ERRORS

Help	Error	File a Report
		
<p>Press <b>HELP</b> in the main <b>MENU</b> to access the Troubleshooting tab.</p>	<p>Fix the error with the provided information. If the error proceeds to appear, contact us by pressing <b>REPORT</b>.</p>	<p>If still in need of service, send us a message with a short description of the problem and general information. Press <b>SEND</b>.</p>

## INFORMATION SIGNALS

POWER DIODE	START/STOP DIODE	SOUND	ACTION	COMMUNICATION
		-	Green light	Device turned off
		-	Green light	Device is ready to work
		-	Green blinking	Starting procedure
		-		Working
		-	Blue light	No fuel
		-	Blue blinking	Refueling
			Blue blinking with sound	Full tank
			Red light	Extinguishing, cooling
			Purple light with sound	Error – check the app (troubleshooting) and contact with service
		-	Blue, red blinking	Fuel tank is empty during the burning process
WI-FI DIODE			ACTION	COMMUNICATION
			Blue light	Not connected to wi-fi
			Blue blinking	Pairing / configuration
			Green light	Wi-fi connected

**FUEL** - Use only ethanol fuel produced from plants in the process of two-time alcohol distillation consisting of 95-96.6% ethanol by volume. Fanola is the recommended fuel with pharmacological purity.

**DO NOT USE SYNTHETIC PETROLEUM BASED FUELS AS THEY ARE CONTAMINATED, EMIT UNPLEASANT ODORS AND CAN DAMAGE THE FIREPLACE! DO NOT USE FUELS CONTAINING 100% ETHANOL BY VOLUME, GEL, OR AROMATIC FUELS!**

**CLEANING** – Clean with a damp cloth and delicate detergents, only when the device is turned off and cooled.

**SERVICE** – Keep the provided USB cable for service. Reach out to us at [service@planikafires.com](mailto:service@planikafires.com).

## BRENNSTOFFNACHFÜLLEN

1. Schalten Sie das Gerät ein, indem Sie drücken. .
2. Wenn der Kraftstofftank leer ist (**START/STOPP-TASTE BLAUES LICHT AN**), öffnen Sie die Klappe und ziehen Sie den Kraftstoffschlauch (I) heraus. Das lose Ende in den Kraftstoffbehälter stecken und den Knopf der Kraftstoffpumpe (II) drücken und halten.
3. Wenn sich der Tank füllt (**START/STOPP-KNOPF GRÜNES LICHT AN**), setzen Sie den Kraftstoffschlauch wieder ein. (III)

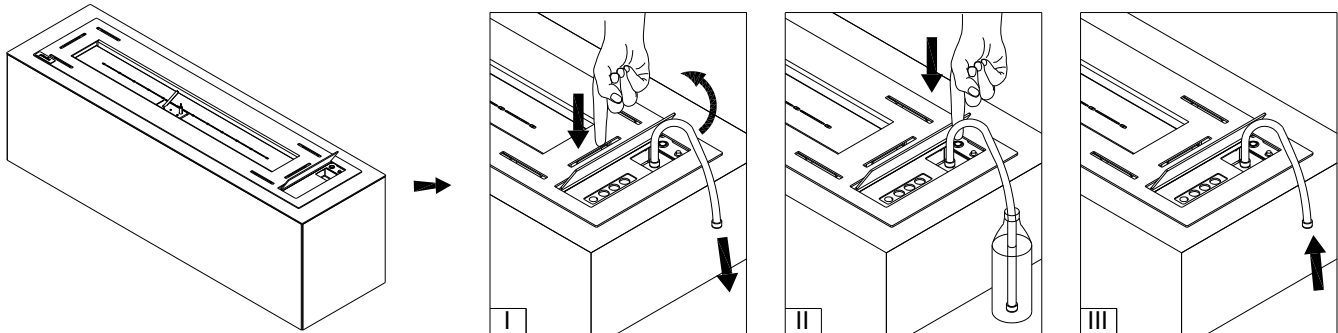



## FLAMMENZÜNDUNG

Die grün beleuchtete Taste **START / STOP** heisst, dass das Gerät bereit ist um die Flammenzündung zu starten.

Drücken Sie **START**. Die Flammenzündung dauert 2-10 Minuten (**BLINKENDE GRÜNE LEUCHTDIODE**). In dieser Zeit kann der Geruch von Kraftstoffdämpfen zu spüren sein. Das Erlöschen der Leuchtdioden ist eine Information, dass die Flamme gezündet wurde und der Kamin die Betriebstemperatur erreicht hat.

## REGULIERUNG DER FLAMMENHÖHE

Wenn die Flamme brennt, drücken Sie  oder  auf der Fernbedienung oder den Flammenpegelbalken verschieben in der Applikation, um die Flammenhöhe auf 6 Niveaus zu vergrössern oder zu verkleinern. Das Gerät schaltet sich standardmäßig mit einer Flammenhöhe auf dem 4 Niveau.

**ACHTUNG!** Falls der Kamin zu hohe Temperatur erreicht, wird die Flamme automatisch verringert und die Möglichkeit die Flammenhöhe zu ändern wird blockiert. Falls die Temperatur weiter ansteigen wird, wird die Flamme ausgelöscht (**ROTE LEUCHTDIODE**).

## FLAMMENAUSLÖSCHUNG

Um die Flamme auszulöschen:

- drücken Sie **STOP**.

**Blinkende rote Leuchtdiode** bedeutet, dass das Gerät gekühlt wird. Die erneute Flammenzündung ist erst nach Abkühlung des Gerätes möglich (**GRÜNE LEUCHTDIODE**).



## AUSSCHALTUNG DES GERÄTES

Um das Gerät vollständig auszuschalten, drücken Sie .

Das Gerät wird sich automatisch ausschalten, wenn irgendwelche Fehler im Arbeitsmodus auftreten (überprüfen Sie den Fehler in der Applikation).

## KONFIGURATION DER DRAHTLOSEN VERBINDUNG

Paarung des Gerätes mit der Applikation wird folgend durchgeführt (gleichzeitig kann nur ein Gerät gepaart werden):

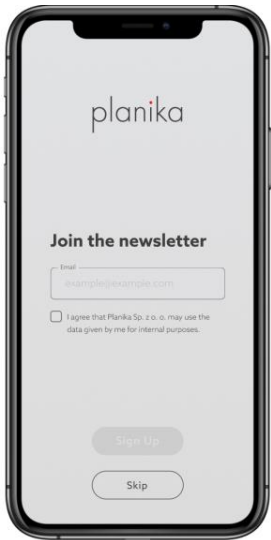
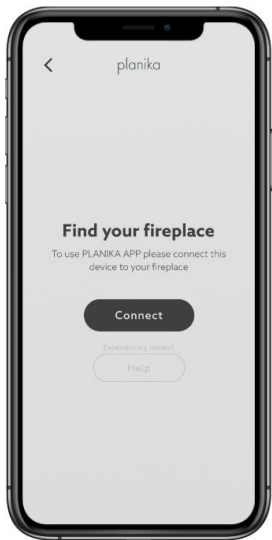
<p style="text-align: center;"><b>Join the newsletter</b></p> <p>1. Schalten Sie bitte die <b>FLA3 NET-ZERO</b> Applikation auf dem Handy ein. Bestätigen Sie den Wunsch des Beitritts zum Newsletter, indem Sie die E-Mailadresse eintragen und auf <b>SIGN UP</b> drücken oder übergehen Sie zum <b>SKIP</b></p> <div style="display: flex; justify-content: space-around; margin-top: 10px;"> <div style="text-align: center;"> <p>Google play</p>  </div> <div style="text-align: center;"> <p>Appstore</p>  </div> </div>		<p style="text-align: center;"><b>Find your fireplace</b></p> <p>2. Auf dem Bildschirm zeigt sich <b>FIND YOUR FIREPLACE</b>. Drücken Sie <b>CONNECT</b> um die Netzsuche zu starten.</p>	
--	---	---	---

3. Drücken Sie und halten die WIFI - Taste  auf dem Kamin. Das Blinken der Taste bedeutet, dass das Gerät zur Paarung bereit ist. Im Fall, das keine Aktivität stattfindet, wird die Bereitschaft nach 5 Minuten annulliert.

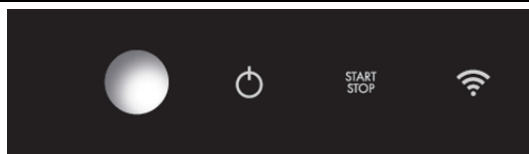

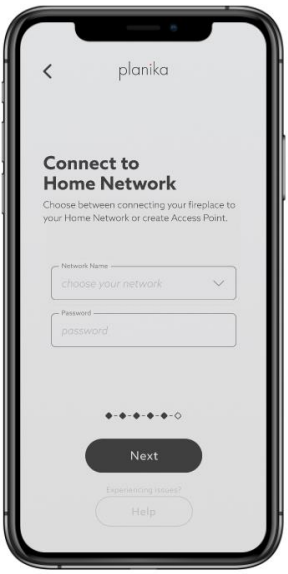
<p style="text-align: center;"><b>Setup Network Active</b></p> <p>4. Gehen Sie zu den Einstellungen des Mobilgerätes, schalten Sie das WiFi ein und verbinden mit dem Netz <b>Fireplace_WiFi_setup</b> (wenn das Netz nicht zu sehen ist, schalten Sie die Stromversorgung des FLA Gerätes für 10 Sekunden ab und wiederholen Sie die Konfiguration. Der Kamin wird automatisch durch die Applikation aufgefunden. Dies wird durch die Information <b>SETUP NETWORK ACTIVE</b> bestätigt. Drücken Sie <b>CONNECT</b>.</p>		<p style="text-align: center;"><b>Connect to Home Network</b></p> <p>5. Auf dem Bildschirm <b>CONNECT TO HOME NETWORK</b> wählen Sie den Netznamen, welchen Sie im Endeffekt benutzen möchten (<b>NETWORK NAME</b>) und geben deren Passwort ein. Überprüfen Sie, dass das Passwort richtig ist und drücken Sie (<b>SUBMIT</b>).</p>	
---	---	--	---





Your fireplaces		Access Point	
<p>6. Auf dem nächsten Bildschirm <b>YOUR FIREPLACES</b>, wählen Sie das Gerät aus und drücken <b>CONNECT</b>. Auf dem Bildschirm können Sie den Namen des Kamins anpassen, indem Sie auf <b>EDIT</b> drücken.</p>		<p>7. Wenn Sie keinen von den verfügbaren Netzen verwenden möchten, können Sie ein gewidmetes Netz erschaffen durch <b>ACCESS POINT</b> und sich direkt mit dem Gerät zu verbinden. Um dies zu tun, drücken Sie (<b>HELP</b>), wählen (<b>CONNECTION TYPE</b>) und nachhinein (<b>ACCESS POINT</b>) mit drücken des (<b>CREATE ACCESS POINT</b>) zu bestätigen. Fügen Sie den Netznamen und das Passwort ein, bestätigen Sie durch das drücken von <b>NEXT</b>.</p>	



Nach einer gelungenen Konfiguration wird die WIFI Leuchtdiode grün angezeigt.



**APPLIKATION FLA3 NET-ZERO**



	<ol style="list-style-type: none"> <li>1. Newsletter</li> <li>2. Kaminmodus</li> <li>3. Flammenhöhe</li> <li>4. Flammenzündung und – auslöschung</li> <li>5. Info</li> <li>6. Menü</li> </ol>
---	---

## MENU

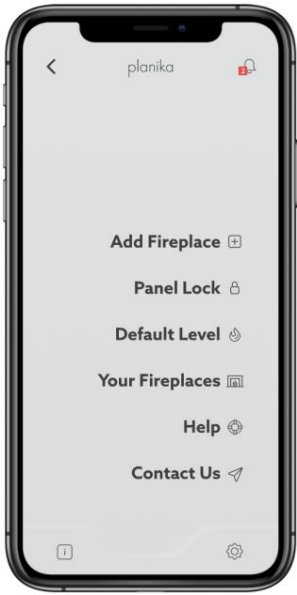
Das Menü ist erreichbar durch das Drücken der Ikone . Die Rückkehr zum Hauptpaneel ist möglich durch das Drücken der **ZURÜCK**  Taste.

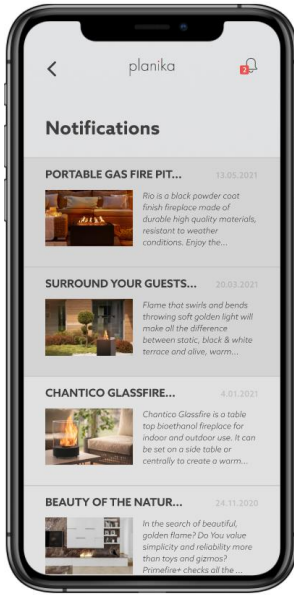
Um die allgemeinen Informationen über den Kamin zu bekommen, drücken Sie . Das Newsletter ist erreichbar durch das Drücken auf die Ikone .

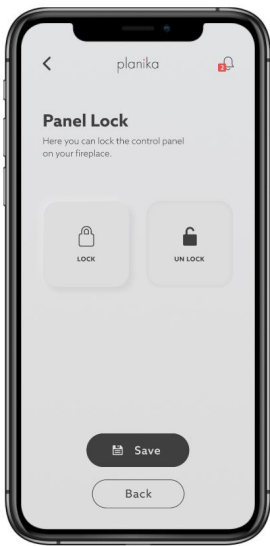

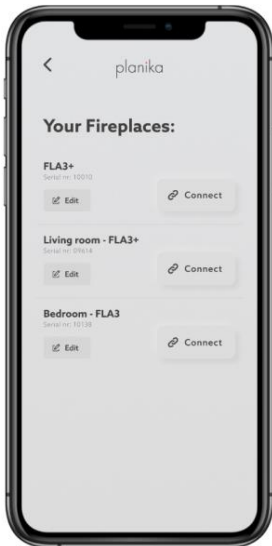
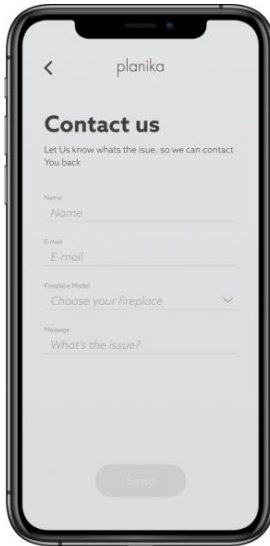





Menu	Info	Newsletter
		
<p>Haupteinstellungen der Applikation. Drücken Sie den Bookmark, um die Einstellungen zu ändern.</p>	<p>Drücken Sie, um die Hauptinformationen über den Kamin zu prüfen.</p>	<p>Drücken Sie, um Benachrichtigungen zu prüfen.</p>

Panel Lock	Default Level	Your fireplaces	Contact Us
			
<p>Drücken Sie <b>LOCK</b>, um den Steuerpaneel des Kamins zu blockieren. Drücken Sie <b>UNLOCK</b>, um den Steuerpaneel des Kamins freizuschalten. Bestätigen Sie die Auswahl durch das Drücken der <b>SAVE</b> Taste. Die Änderung ist nur bei dem erloschenen Gerät möglich.</p>	<p>Stellen Sie das Niveau der Flamme ein, auf dem der Kamin seine Arbeit anfangen wird nach dem Start. Drücken Sie <b>SAVE</b>, um die Änderungen zu speichern. <b>RESET</b>, um die Einstellungen neuzustarten. Das Gerät schaltet sich standardmäßig mit einer Flammenhöhe auf dem 4 Niveau.</p>	<p>Überprüfen Sie die verfügbaren Kamine. Drücken Sie <b>EDIT</b>, um den Namen des Gerätes zu ändern. Drücken Sie <b>CONNECT</b>, um sich mit dem Gerät zu verbinden.</p>	<p>Kontaktieren Sie Planika durch durch E-Mail. Drücken Sie <b>SEND</b>, um die Nachricht zu verschicken.</p>

## ALARMMITTEILUNGEN

Help	Error	File a Report
		
<p>Drücken Sie <b>HELP</b> im <b>MENU</b>, um zum Bookmark <b>Troubleshooting</b> zu gelangen.</p>	<p>Führen Sie die Tätigkeit aus, die den Fehler betrifft. Wenn der <b>ERROR</b> weiterhin aufgezeigt wird, melden Sie die Angelegenheit durch das Drücken der <b>REPORT</b> Taste.</p>	<p>Wenn Sie weiterhin die Hilfe des Service benötigen, so senden Sie die Nachricht mit der Beschreibung des Fehlers und den Basisinformationen durch <b>SEND</b>.</p>

## INFORMATIONSSIGNALE

STROM-DIODEN	START/STOPP-DIODE	TON	AKTION	KOMMUNIKATION
		-	Grüner Blitz	Gerät ist ausgeschaltet
		-	Grünes Blinken	Gerät ist einsatzbereit
		-	Grün blinkend	Startvorgang
		-	In Betrieb	In Betrieb
		-	Blau blinken	Kein Kraftstoff
		-	Blau blinkend	Tanken
			Blau blinkend mit Ton	Voller Tank
			Rotes Blinken	Entlüften, Kühlen
			Lila blinken mit Ton	Fehler - App überprüfen (Fehlersuche) und Kontakt mit dem Service aufnehmen
		-	Blau, rot blinkend	Kraftstofftank ist während des Brennvorgangs leer
WI-FI DIODEN		AKTION		KOMMUNIKATION
		Blaues Blinken		Nicht mit Wi-Fi verbunden
		Blau blinkend		Kopplung/Konfiguration
		Grünes Blinken		Wi-fi verbunden

**BRENNSTOFF** - Verwenden Sie nur Ethanolkraftstoff, der aus Pflanzen im Prozess der zweimaligen Alkoholdestillation hergestellt wird und aus 95-96,6 Vol.-% Ethanol besteht. Fanola ist der empfohlene Brennstoff mit pharmakologischer Reinheit.

VERWENDEN SIE KEINE SYNTHETISCHEN BRENNSTOFFE AUF ERDÖLBASIS, DA DIESE VERUNREINIGT SIND, UNANGENEHME GERÜCHE ABGEBEN UND DEN KAMIN BESCHÄDIGEN KÖNNEN! VERWENDEN SIE KEINE KRAFTSTOFFE MIT 100 VOL.-% ETHANOL, GEL ODER AROMATISCHE KRAFTSTOFFE!

**REINIGUNG** – Mit einem feuchten Lappen und milden Reinigungsmittel reinigen, nur wenn der Kamin ausgeschaltet und abgekühlt ist.

**SERVICE** – Für Servicezwecke bewahren Sie das mitgelieferte USB-Kabel auf. Kontakt: [service@planikafires.com](mailto:service@planikafires.com)

## RELLENO DEL COMBUSTIBLE

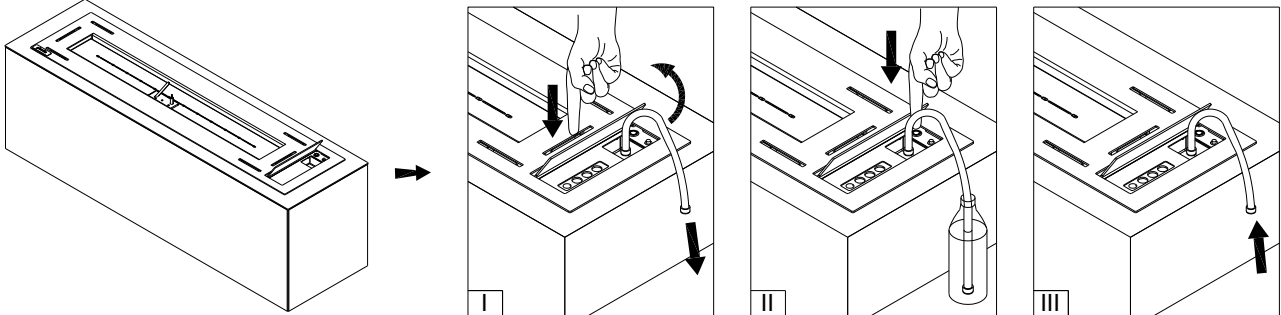

1. Encienda el dispositivo pulsando .
2. Si el depósito de combustible está vacío (**LUZ AZUL DEL BOTÓN START/STOP ENCENDIDA**), abra la tapa y extraiga la manguera de combustible (I). Coloque el extremo suelto en el recipiente de combustible y mantenga pulsado el botón de la bomba de combustible (II).
3. Si el depósito se llena (**BOTÓN DE ARRANQUE/PARADA LUZ VERDE ENCENDIDA**), vuelva a colocar la manguera de combustible en su sitio. (III)



## ENCENDIDO DE LA LLAMA

El botón **START / STOP** iluminado en verde significa que el dispositivo está listo para encender la llama. Presiona **START**. Se tarda entre 2 y 10 minutos en encender la llama (**LED VERDE PARPADEANDO**). Durante este tiempo, puede oler los vapores del combustible. Los diodos de extinción informan que la llama se ha encendido y el dispositivo ha alcanzado su temperatura de funcionamiento.

## REGULACIÓN DE LA ALTURA DE LLAMA

Mientras la llama está encendida, presione  o  en el control remoto o desplazar la barra de nivel de llama en la aplicación para aumentar o disminuir su altura en 6 niveles. La llama se dispara a la 4ª altitud de forma predeterminada. **¡ATENCIÓN!** En caso de una temperatura demasiado alta del dispositivo, la altura de la llama se reducirá automáticamente y se bloqueará su ajuste. Si la temperatura sigue subiendo, la llama se apagará (**LED ROJO**)

## APAGAR LA LLAMA

Para apagar la llama:

- presione **STOP**.

**LED ROJO parpadeante** significa que el dispositivo se está enfriando. El reencendido de la llama solo es posible después de que el dispositivo se haya enfriado (**LED VERDE**).

## APAGAR EL DISPOSITIVO

Para apagar el dispositivo por completo, presione .

El dispositivo se apagará automáticamente en caso de detectar algún mal funcionamiento (verifique el error en la aplicación).

## CONFIGURACIÓN LA COMUNICACIÓN INALÁMBRICA

El dispositivo se configura con la aplicación de la siguiente manera (solo se puede configurar un dispositivo a la vez):

<p style="text-align: center;"><b>Join the newsletter</b></p> <p><b>1.</b> Inicie las <b>FLA3 NET-ZERO</b> aplicaciones en el teléfono. Confirme su voluntad de unirse al boletín ingresando su dirección de correo electrónico y haciendo clic en <b>SIGN UP</b> o salte la etapa haciendo clic en <b>SKIP</b></p> <div style="display: flex; justify-content: space-around; margin-top: 10px;"> <div style="text-align: center;"> <p>Google play</p>  </div> <div style="text-align: center;"> <p>Appstore</p>  </div> </div>		<p><b>Find your fireplace</b></p> <p><b>2.</b> En la pantalla <b>FIND YOUR FIREPLACE</b>, haga clic en <b>CONNECT</b> para comenzar a buscar una red.</p>	
---	---	---	---

- 3.** Mantenga presionado el botón WIFI  en la chimenea. El parpadeo del botón significa que la chimenea está lista para configurarse. El modo de espera se cancelará después de 5 minutos en caso de inactividad.

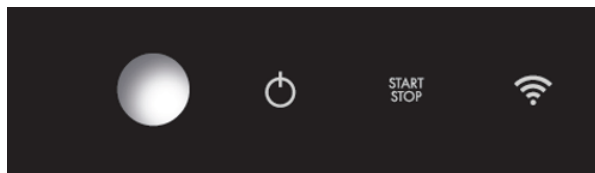

<p><b>Setup Network Active</b></p> <p><b>4.</b> Vaya a la configuración del dispositivo móvil, encienda la red WiFi y conéctese a la red <b>Fireplace_WiFi_setup</b> (si la red no está visible, desconecte el dispositivo FLA durante 10 segundos y repita la configuración). La aplicación buscará automáticamente la chimenea. Esto será confirmado por el mensaje <b>SETUP NETWORK ACTIVE</b>. Haga clic en <b>CONNECT</b>.</p>		<p><b>Connect to Home Network</b></p> <p><b>5.</b> En la pantalla <b>CONNECT TO HOME NETWORK</b>, seleccione el <b>(NETWORK NAME)</b> que desea usar e ingrese su contraseña. Asegúrese de que la contraseña sea correcta y haga clic en <b>(SUBMIT)</b>.</p>	
---	---	---	---





Your fireplaces		Access Point	
<p>6. En la siguiente pantalla <b>YOUR FIREPLACES</b>, seleccione el dispositivo que le interesa y haga clic en <b>CONNECT</b>. En esta pantalla, también puede personalizar el nombre de la chimenea haciendo clic en <b>EDIT</b>.</p>		<p>7. Si no desea utilizar ninguna de las redes disponibles, puede crear una red de <b>ACCESS POINT</b> dedicada y conectarse directamente al dispositivo. Para hacer esto, haga clic en <b>(HELP)</b>, seleccione <b>(CONNECTION TYPE)</b> y luego <b>(ACCESS POINT)</b> confirmando haciendo clic en <b>(CREATE ACCESS POINT)</b>. Ingrese el nombre de la red y la contraseña, confirme haciendo clic en <b>NEXT</b>.</p>	

Después de una configuración, el **LED WIFI** será verde



### APLICACION FLA3 NET-ZERO

	<ol style="list-style-type: none"> <li>1. Newsletter</li> <li>2. Modo chimenea</li> <li>3. Altura de la llama</li> <li>4. Apagar y encender</li> <li>5. Info</li> <li>6. Menu</li> </ol>
---	--

## MENU

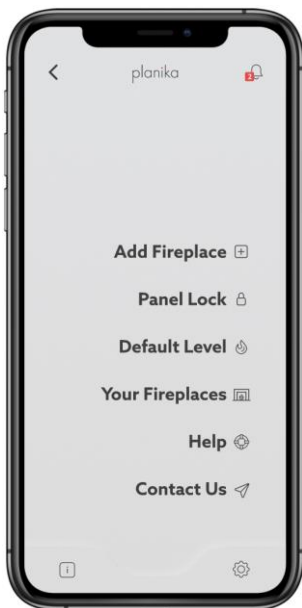
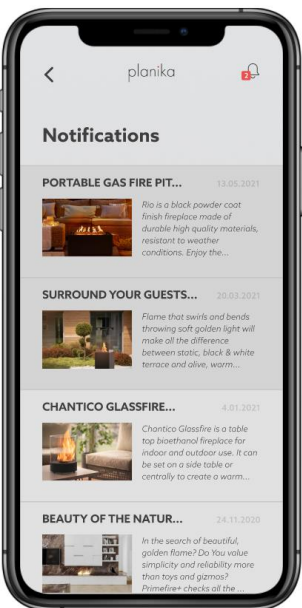
El menú está disponible después de hacer clic en el icono . Puede volver al panel principal después de hacer clic en **ATRÁS** . Para obtener información general sobre la chimenea, haga clic en el icono . Newsletter está disponible después de hacer clic en el icono .

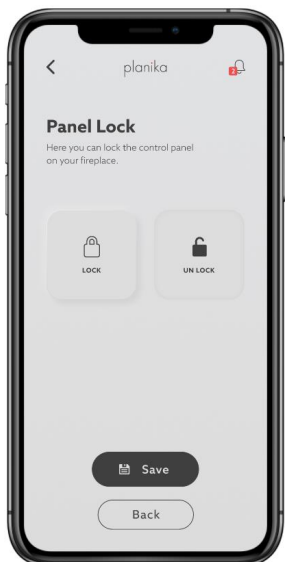

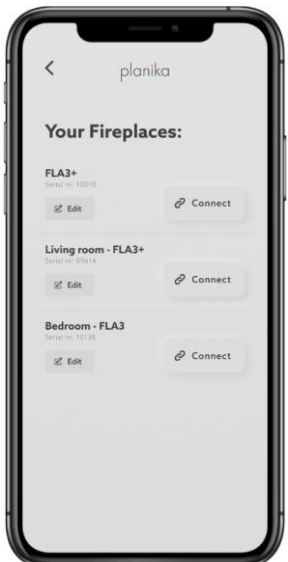
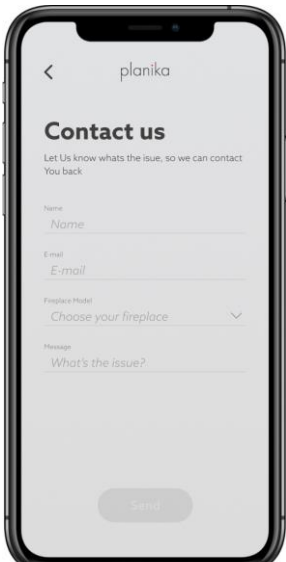









Menu	Info	Newsletter
		
<p>Configuración de la aplicación principal. Haga clic en la pestaña para cambiar la configuración.</p>	<p>Haga clic aquí para consultar la información básica sobre la chimenea.</p>	<p>Haga clic aquí para consultar las notificaciones.</p>

Panel Lock	Default Level	Your fireplaces	Contact Us
			
<p>Haga clic en <b>LOCK</b> para bloquear el panel de control de la chimenea. Haga clic en <b>UNLOCK</b> para desbloquear el panel de control de la chimenea. Confirme su selección con el botón <b>SAVE</b>. El cambio solo es posible en el dispositivo apagado.</p>	<p>Establezca el nivel de llama en el que la chimenea comenzará a funcionar cuando la encienda. Haga clic en <b>SAVE</b> para guardar los cambios. <b>RESET</b> para restablecer la configuración. La llama viene ajustada de fábrica al nivel 4.</p>	<p>Consulte las chimeneas disponibles. Haga clic en <b>EDIT</b> para editar el nombre del dispositivo. Haga clic en <b>CONNECT</b> para conectarse al dispositivo.</p>	<p>Póngase en contacto con Planika por correo electrónico. Haga clic en <b>SEND</b> para enviar el mensaje.</p>

## MENSAJES DE ALARMA

Help	Error	File a Report
		
Haga clic en <b>HELP</b> en el <b>MENU</b> principal para ir a la pestaña Troubleshooting.	Toma la acción por la falla. Si el error persiste, informe el problema haciendo clic en <b>REPORT</b> .	Si aún necesita ayuda del servicio, envíe un mensaje con una descripción de la falla e información básica haciendo clic en <b>SEND</b> .

## SEÑALES DE INFORMACIÓN

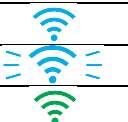
DIODO DE POTENCIA	DIODO DE ARRANQUE/PARADA	SONIDO	ACCIÓN	COMUNICACIÓN
		-	Flash verde	Dispositivo apagado
		-	Verde intermitente	El dispositivo está listo para funcionar
		-	Verde parpadeante	Procedimiento de arranque
		-	Funcionando	Funcionando
		-	Parpadeo azul	No hay combustible
		-	Azul parpadeante	Repostar
			Azul parpadeante con sonido	Depósito lleno
			Parpadeo rojo	Extinguir, enfriar
			Púrpura parpadeante con sonido	Error - compruebe la aplicación (solución de problemas) y contacte con el servicio técnico
		-	Azul, rojo intermitente	El depósito de combustible está vacío durante el proceso de combustión
<b>DIODO WI-FI</b>			<b>ACCIÓN</b>	<b>COMUNICACIÓN</b>
			Parpadeo azul	No está conectado a wi-fi
			Azul parpadeante	Emparejamiento / configuración
			Parpadeo verde	Wi-fi conectado

**COMBUSTIBLE** - Use solo combustible de etanol producido a partir de plantas en el proceso de destilación de alcohol dos veces que consta de 95-96,6% de etanol por volumen. Fanola es el combustible recomendado con pureza farmacológica.

**¡NO USE COMBUSTIBLES SINTÉTICOS A BASE DE PETRÓLEO YA QUE ESTÁN CONTAMINADOS, EMITEN OLORES DESAGRADABLES Y PUEDEN DAÑAR LA CHIMENEA! ¡NO UTILICE COMBUSTIBLES QUE CONTENGAN 100 % DE ETANOL POR VOLUMEN, GEL O COMBUSTIBLES AROMÁTICOS!**

**LIMPIEZA** - Limpie con un paño húmedo y un detergente suave cuando el aparato esté apagado y enfriado.

**SERVICIO** - conserve el cable USB incluido para realizar el servicio. Correo electrónico de contacto [service@planikafires.com](mailto:service@planikafires.com)



## RAVITAILLEMENT DU CARBURANT

1. Allumez l'appareil en appuyant sur .
2. Si le réservoir de carburant est vide (**VOYANT BLEU DU BOUTON START/STOP ALLUMÉ**), ouvrez la trappe et retirez le tuyau de carburant (I). Placez l'extrémité libre dans le réservoir de carburant et appuyez sur le bouton de la pompe à carburant (II) en le maintenant enfoncé.
3. Si le réservoir se remplit (**TOUCHE DE DÉMARRAGE/ARRÊT VOYANT VERT ALLUMÉE**), remettez le tuyau de carburant en place. (III)

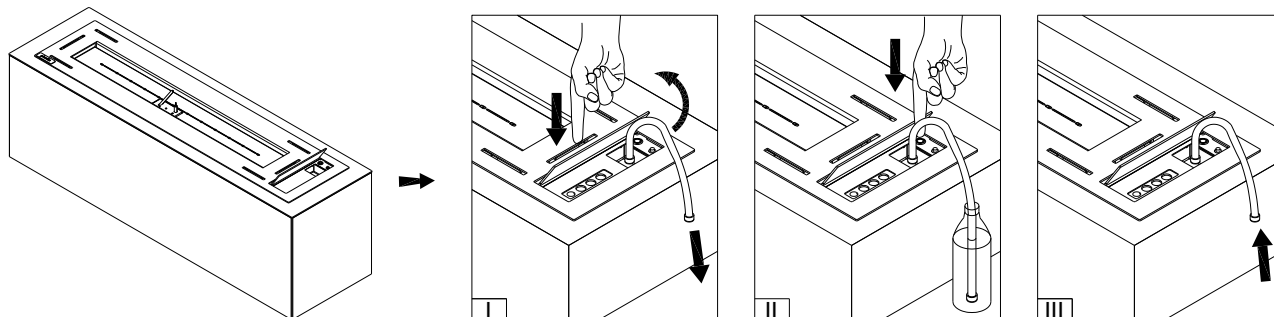



## ALLUMAGE DE LA FLAMME

Le bouton **START / STOP** allumé en vert signifie que l'appareil est prêt à allumer la flamme.

Appuyez sur **Start**. Il faut 2 à 10 minutes pour allumer la flamme (**LED VERTE CLIGNOTANTE**). Pendant ce temps, vous pouvez sentir les vapeurs de carburant. Les diodes d'extinction signalent que la flamme s'est allumée et que l'appareil a atteint sa température de fonctionnement.

## RÉGLAGE DE LA HAUTEUR DE FLAMME

Pendant que la flamme brûle, appuyez sur  ou  sur la télécommande ou déplacer la barre de hauteur de la flamme dans l'application pour augmenter ou diminuer sa hauteur sur 6 niveaux. La flamme se déclenche à la 4ème altitude. **ATTENTION!** En cas de température trop élevée de l'appareil, la hauteur de la flamme sera automatiquement réduite et son réglage est bloqué. Si la température continue d'augmenter, la flamme s'éteindra (**LED ROUGE**)

## ÉTEINDRE LA FLAMME

Pour éteindre la flamme :

- appuyez sur **STOP**.

La **LED rouge clignotante** signifie que l'appareil refroidit. Le rallumage de la flamme n'est possible qu'après refroidissement de l'appareil (**LED VERTE**).



## ÉTEINDRE LE DISPOSITIF

Pour éteindre complètement l'appareil, appuyez sur .

L'appareil s'éteindra automatiquement en cas de détection de dysfonctionnements (vérifiez l'erreur dans l'application).

## CONFIGURATION DE COMMUNICATION SANS FIL

L'appareil est associé à l'application comme suit (un seul appareil peut être associé à la fois) :

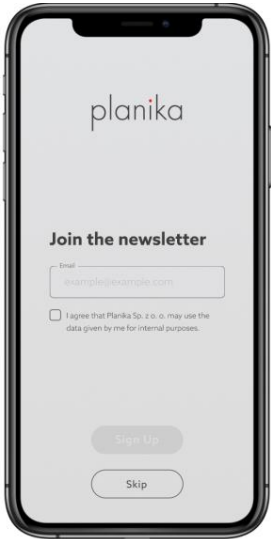
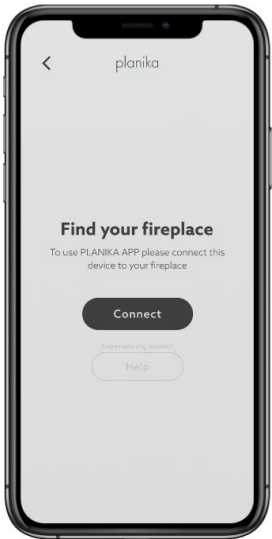
<p><b>Join the newsletter</b></p> <p>1. Lancez les <b>FLA3 NET-ZERO</b> applications sur le téléphone. Confirmez votre volonté de vous inscrire à la newsletter en entrant votre adresse e-mail et en cliquant sur <b>SIGN UP</b> ou passez l'étape en cliquant sur <b>SKIP</b></p> <div style="display: flex; justify-content: space-around; margin-top: 10px;"> <div style="text-align: center;"> <p>Google play</p>  </div> <div style="text-align: center;"> <p>Appstore</p>  </div> </div>		<p><b>Find your fireplace</b></p> <p>2. Sur l'écran <b>FIND YOUR FIREPLACE</b>, cliquez sur <b>CONNECT</b> pour lancer la recherche d'un réseau</p>	
---	---	---	---

3. Appuyez et maintenez enfoncé le bouton **WiFi**  sur la cheminée. Le clignotement du bouton signifie que le foyer est prêt pour la configuration. La mise en veille sera annulée après 5 minutes en cas d'inactivité.

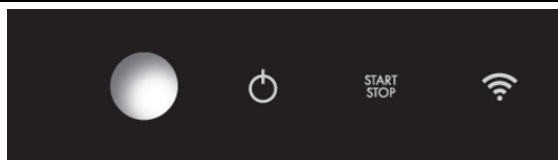

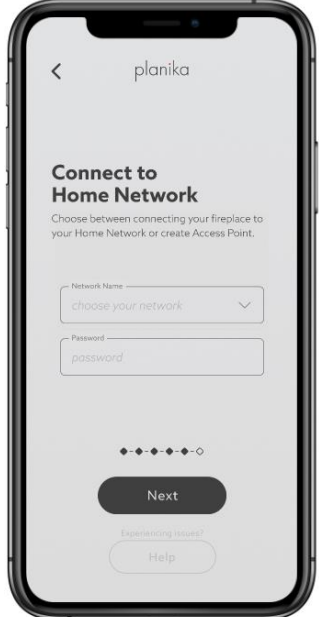
<p><b>Setup Network Active</b></p> <p>4. Accédez aux paramètres de l'appareil mobile, activez le réseau WiFi et connectez-vous au réseau <b>Fireplace_WiFi_setup</b> (si le réseau n'est pas visible, déconnectez l'appareil FLA pendant 10 secondes et répétez la configuration). La cheminée sera automatiquement recherchée par l'application. Ceci sera confirmé par le message <b>SETUP NETWORK ACTIVE</b>. Cliquez sur <b>CONNECT</b>.</p>		<p><b>Connect to Home Network</b></p> <p>5. Sur l'écran <b>CONNECT TO HOME NETWORK</b>, sélectionnez le <b>(NETWORK NAME)</b> que vous souhaitez utiliser et entrez son mot de passe. Assurez-vous que le mot de passe est correct et cliquez sur <b>(SUBMIT)</b>.</p>	
--	---	--	---



Your fireplaces		Access Point	
<p>6. Sur l'écran suivant <b>YOUR FIREPLACES</b>, sélectionnez l'appareil qui vous intéresse et cliquez sur <b>CONNECT</b>. Sur cet écran, vous pouvez également personnaliser le nom du foyer en cliquant sur <b>EDIT</b>.</p>		<p>7. Si vous ne souhaitez utiliser aucun des réseaux disponibles, vous pouvez créer un réseau <b>ACCESS POINT</b> dédié et vous connecter directement à l'appareil. Pour cela, cliquez sur <b>(HELP)</b>, sélectionnez <b>(CONNECTION TYPE)</b> puis <b>(ACCESS POINT)</b> validez en cliquant sur <b>(CREATE ACCESS POINT)</b>. Entrez le nom du réseau et le mot de passe, confirmez en cliquant sur <b>NEXT</b>.</p>	



Après une configuration réussie, la LED WIFI sera verte



### APPLICATION FLA3 NET-ZERO



	<ol style="list-style-type: none"> <li>1. Newsletter</li> <li>2. Mode cheminée</li> <li>3. Hauteur de la flamme</li> <li>4. Éteindre et allumer</li> <li>5. Informations</li> <li>6. Menu</li> </ol>
---	--

## MENU

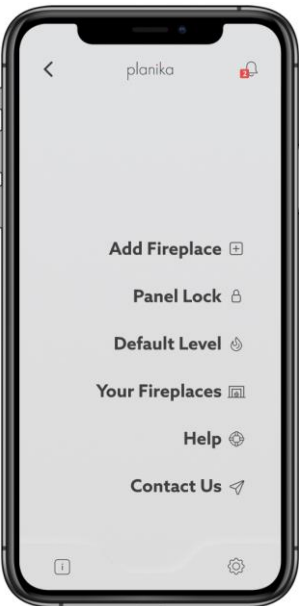
Le menu est accessible après avoir cliqué sur l'icône . Vous pouvez revenir au panneau principal après avoir cliqué sur **RETOUR** 

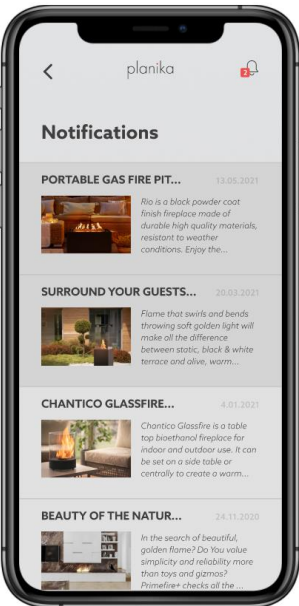
Pour obtenir des informations générales sur la cheminée, cliquez sur l'icône . La newsletter est disponible après avoir cliqué sur l'icône 

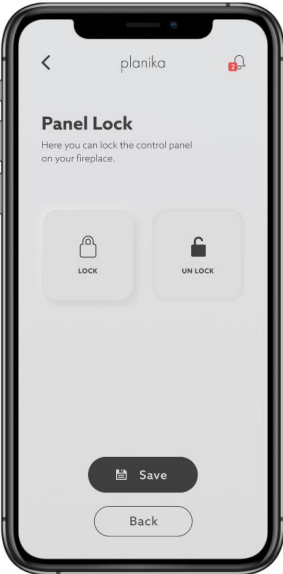

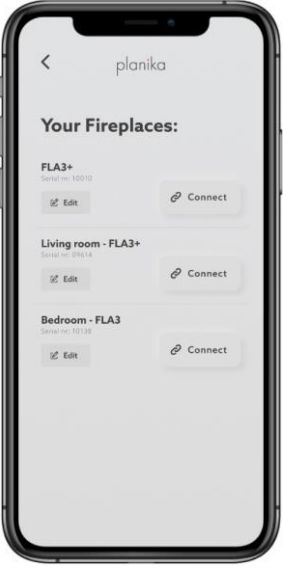
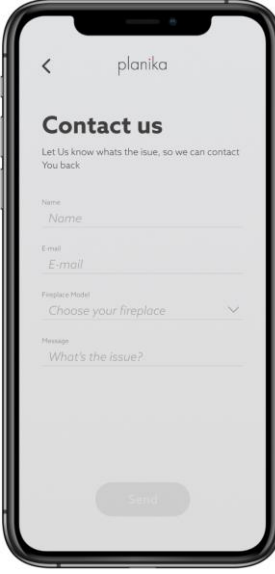



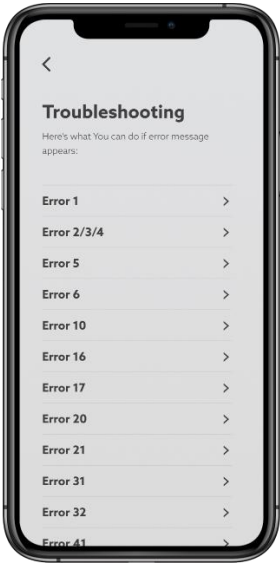
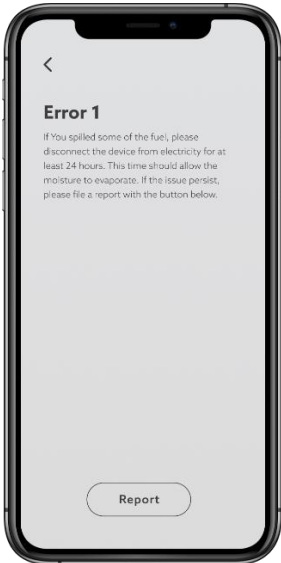
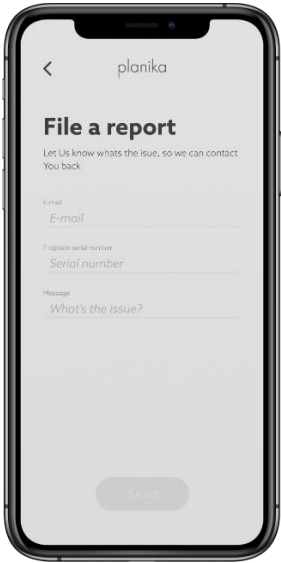





Menu	Info	Newsletter
		
<p>Paramètres principaux de l'application. Cliquez sur l'onglet pour modifier les paramètres.</p>	<p>Cliquez ici pour vérifier les informations de base sur la cheminée.</p>	<p>Cliquez ici pour vérifier les notifications.</p>

Panel Lock	Default Level	Your fireplaces	Contact Us
			
<p>Cliquez sur <b>LOCK</b> pour verrouiller le panneau de commande du foyer. Cliquez sur <b>UNLOCK</b> pour déverrouiller le panneau de commande du foyer. Confirmez votre sélection avec le bouton <b>SAVE</b></p>	<p>Réglez le niveau de flamme auquel le foyer commencera à fonctionner lorsque vous l'allumerez. Cliquez sur <b>SAVE</b> pour enregistrer les modifications. <b>RESET</b> pour réinitialiser les paramètres. La flamme est réglée en usine au niveau 4.</p>	<p>Vérifiez les cheminées disponibles. Cliquez sur <b>EDIT</b> pour modifier le nom de l'appareil. Cliquez sur <b>CONNECT</b> pour vous connecter à l'appareil.</p>	<p>Contactez Planika par e-mail. Cliquez sur <b>SEND</b> pour envoyer le message.</p>

## MESSAGES D'ALARME

Help	Error	File a Report
		
<p> Cliquez sur <b>HELP</b> dans le <b>MENU</b> principal pour accéder à l'onglet Troubleshooting.</p>	<p> Prendre l'action pour la faute. Si l'erreur persiste, veuillez signaler le problème en cliquant sur <b>REPORT</b>.</p>	<p> Si vous avez encore besoin de l'aide du service, envoyez un message avec une description de la panne et des informations de base en cliquant sur <b>SEND</b>.</p>

## SIGNAUX D'INFORMATION

DIODE D'ALIMENTATION	DIODE MARCHE/ARRÊT	SON	ACTION	COMMUNICATION
		-	L'éclair vert	L'appareil est éteint
		-	Flash vert	L'appareil est prêt à fonctionner
		-	Clignotement vert	Procédure de démarrage
		-		Fonctionnement
		-	Bleu clignotant	Pas de carburant
		-	Clignotement bleu	Ravitaillement en carburant
			Clignotement bleu avec son	Réservoir plein
			Rouge clignotant	Vidange, refroidissement
			Flash violet avec son	Erreur - vérifier l'application (dépannage) et contacter le service après-vente.
		-	Bleu, rouge clignotant	Le réservoir de carburant est vide pendant le processus de combustion
DIODE WI-FI			ACTION	COMMUNICATION
			Bleu clignotant	Non connecté au wi-fi
			Bleu clignotant	Jumelage / configuration
			Vert clignotant	Wi-fi connecté

**CARBURANT** - Utilisez uniquement du carburant à l'éthanol produit à partir de plantes dans le processus de distillation d'alcool en deux temps composé de 95 à 96,6% d'éthanol en volume. Fanola est le carburant recommandé avec une pureté pharmacologique.

**N'UTILISEZ PAS DE COMBUSTIBLES À BASE DE PÉTROLE SYNTHÉTIQUE CAR ILS SONT CONTAMINÉS, ÉMETTENT DES ODEURS DÉSAGRÉABLES ET PEUVENT ENDOMMAGER LE FOYER ! N'UTILISEZ PAS DE CARBURANTS CONTENANT 100 % D'ÉTHANOL EN VOLUME, DE GEL OU DE CARBURANTS AROMATIQUES !**

**NETTOYAGE** - Nettoyer avec un chiffon humide et un détergent doux lorsque l'appareil est éteint et refroidi.

**SERVICE** - Conservez le câble USB fourni pour le service. Contactez par e-mail [service@planikafires.com](mailto:service@planikafires.com)

## RIFORNIMENTO DI COMBUSTIBILE

1. Accendere il dispositivo premendo .
2. Se il serbatoio del carburante è vuoto (**PULSANTE DI AVVIAMENTO/ARRESTO ACCESO**), aprire lo sportello ed estrarre il tubo flessibile del carburante (I). Inserire l'estremità libera nel contenitore del carburante e tenere premuto il pulsante della pompa del carburante (II).
3. Se il serbatoio si riempie (**PULSANTE START/STOP VERDE ACCESO**), rimettere il tubo flessibile del carburante al suo posto. (III)

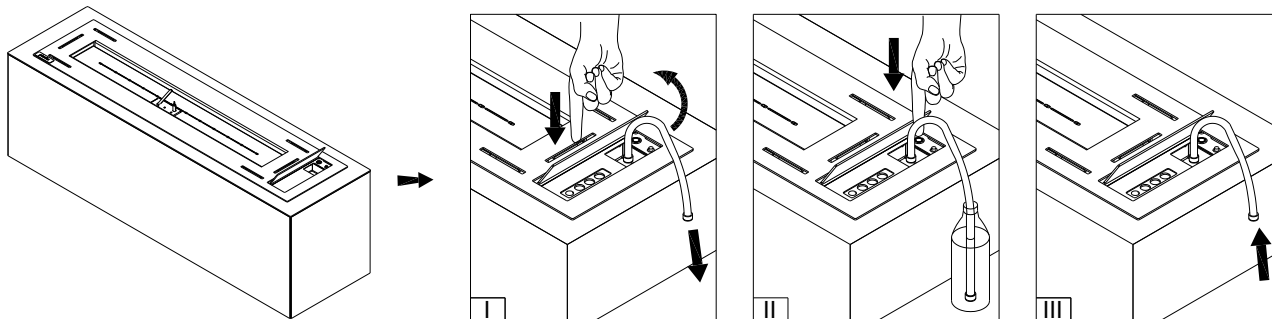



## ACCENSIONE DELLA FIAMMA

Il pulsante **START/STOP** illuminato in verde indica che il dispositivo è pronto per l'accensione della fiamma.

Premere **START**. Occorrono 2-10 minuti per accendere la fiamma (**LED VERDE LAMPEGGIANTE**). Durante questo periodo, è possibile sentire l'odore dei vapori del combustibile. I LED spenti informano che la fiamma è stata accesa e il dispositivo ha raggiunto la sua temperatura di esercizio.

## REGOLAZIONE DELL'ALTEZZA DELLA FIAMMA

Mentre la fiamma è accesa, premere  o  sul telecomando o spostare la barra dell'altezza della fiamma nell'applicazione per aumentare o diminuire la sua altezza (6 livelli disponibili). La fiamma si accende come impostazione di fabbrica sul 4 livello.

**ATTENZIONE!** In caso di temperatura troppo elevata del dispositivo, l'altezza della fiamma verrà automaticamente ridotta e la sua regolazione sarà bloccata. Se la temperatura continua ad aumentare la fiamma si spegne (**LED ROSSO**).

## SPEGNIMENTO DELLA FIAMMA

Per spegnere la fiamma:

- premere **STOP**.

LED rosso lampeggiante indica che il dispositivo si sta raffreddando. La riaccensione della fiamma è possibile solo dopo che il dispositivo si è raffreddato (**LED VERDE**).



## SPEGNIMENTO DEL DISPOSITIVO

Per spegnere completamente il dispositivo, premere .

Il dispositivo si spegnerà automaticamente in caso di irregolarità nel suo funzionamento (verificare l'errore nell'applicazione).

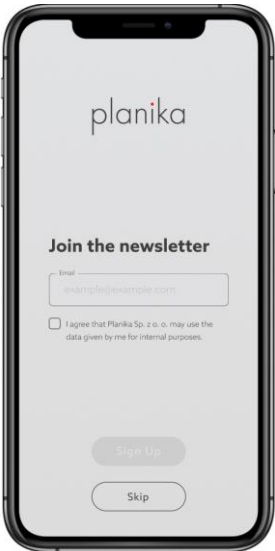
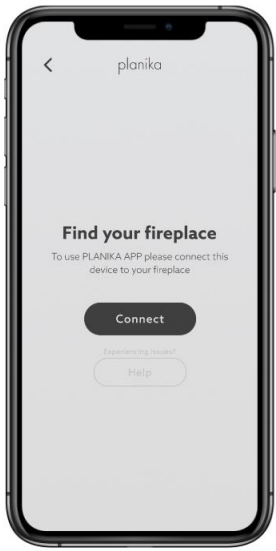

## CONFIGURAZIONE WIRELESS

Il dispositivo viene configurato con l'applicazione come descritto in seguito (è possibile configurare un solo dispositivo alla volta):

<p style="text-align: center;"><b>Join the newsletter</b></p> <p><b>1.</b> Avviare <b>FLA3 NET-ZERO</b> l'applicazione sul telefono. Confermare la volontà di iscriversi alla newsletter inserendo l'indirizzo e-mail e cliccando <b>SIGN UP</b> oppure saltare la fase cliccando <b>SKIP</b></p> <div style="display: flex; justify-content: space-around; margin-top: 10px;"> <div style="text-align: center;"> <p>Google play</p>  </div> <div style="text-align: center;"> <p>Appstore</p>  </div> </div>		<p style="text-align: center;"><b>Find your fireplace</b></p> <p><b>2.</b> Nella schermata <b>FIND YOUR FIREPLACE</b> fare clic su <b>CONNECT</b> per avviare la ricerca di una rete</p>	
---	---	--	---

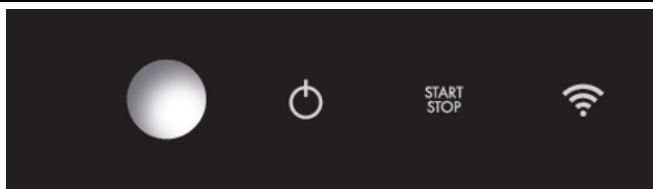
- 3.** Tenere premuto il pulsante WIFI  sul camino. Il lampeggio del pulsante indica che il caminetto è pronto per la configurazione. In caso di inattività, lo standby verrà annullato dopo 5 minuti.

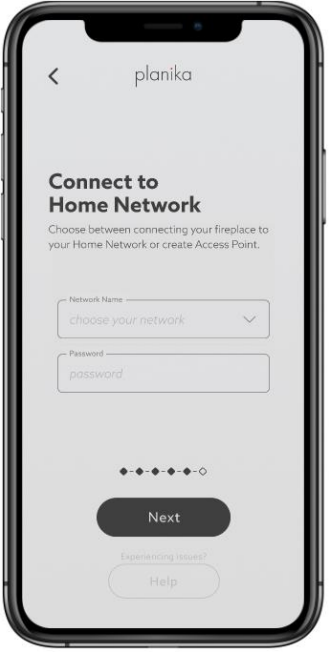

<p style="text-align: center;"><b>Setup Network Active</b></p> <p><b>4.</b> Passare alle impostazioni del dispositivo mobile, accendere la rete WiFi e connettersi alla rete <b>Fireplace_WiFi_setup</b> (se la rete non è visibile, disconnettere il dispositivo FLA per 10 secondi e ripetere la configurazione). Il caminetto verrà ricercato automaticamente dall'applicazione. Come conferma apparirà il messaggio <b>SETUP NETWORK ACTIVE</b> Fare clic su <b>CONNECT</b>.</p>		<p style="text-align: center;"><b>Connect to Home Network</b></p> <p><b>5.</b> Sullo schermo <b>CONNECT TO HOME NETWORK</b> selezionare il nome della rete che si desidera utilizzare (<b>NETWORK NAME</b>) e inserire la password. Assicurarsi che la password sia corretta e fare clic su (<b>SUBMIT</b>).</p>	
--	---	--	---

Your fireplaces		Access Point	
<p>6. Nella schermata successiva <b>YOUR FIREPLACES</b>, selezionare il dispositivo e cliccare <b>CONNECT</b>. In questa schermata è possibile personalizzare il nome del caminetto cliccando <b>EDIT</b>.</p>		<p>7. Se non si desidera utilizzare nessuna delle reti disponibili, è possibile creare una rete <b>ACCESS POINT</b> dedicata e connettersi direttamente al dispositivo. Per fare ciò, fare clic su <b>(HELP)</b>, selezionare <b>(CONNECTION TYPE e poi (ACCESS POINT))</b> confermare cliccando su <b>(CREATE ACCESS POINT)</b>. Immettere il nome della rete e la password, confermare facendo clic su <b>NEXT</b></p>	



Al termine della configurazione, il LED WIFI si illuminerà in verde

### APPLICAZIONE FLA3 NET-ZERO



	<ol style="list-style-type: none"> <li>1. Newsletter</li> <li>2. Modalità camino</li> <li>3. L'altezza della fiamma</li> <li>4. Spegnere e accendere</li> <li>5. Info</li> <li>6. Menu</li> </ol>
---	---



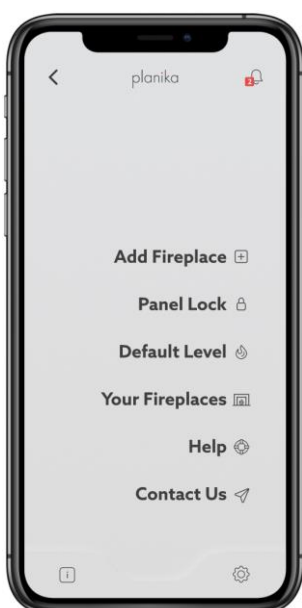

## MENU

Il menu è disponibile dopo aver cliccato sull'icona . Per tornare al pannello principale fare clic su **INDIETRO** 

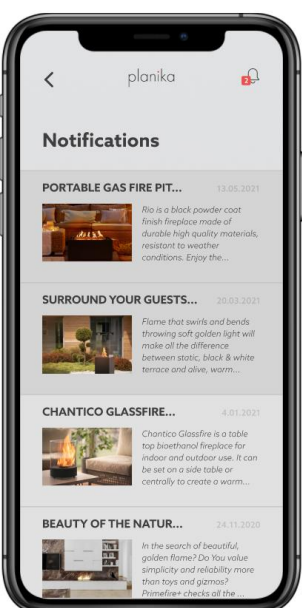
Per informazioni generali sul camino, fare clic sull'icona . Newsletter è disponibile dopo aver cliccato sull'icona 

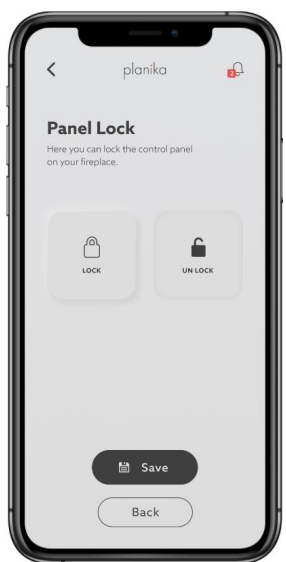

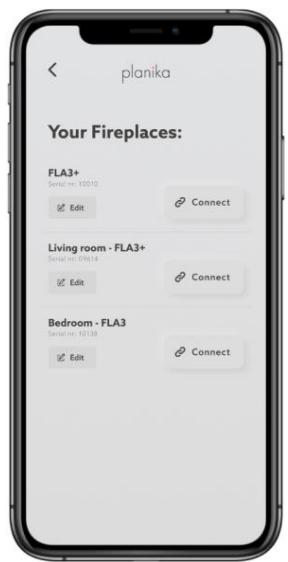
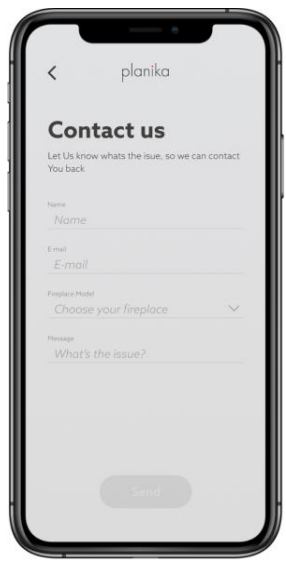









Menu	Info	Newsletter
		
<p>Impostazioni principali dell'applicazione. Fare clic sulla scheda per modificare le impostazioni.</p>	<p>Clicca qui per controllare le informazioni di base sul camino.</p>	<p>Clicca qui per controllare le notifiche.</p>

Panel Lock	Default Level	Your fireplaces	Contact Us
			
<p>Fare clic su <b>LOCK</b> per bloccare il pannello di controllo sul caminetto. Fare clic su <b>UNLOCK</b> per sbloccare il pannello di controllo sul caminetto.. Confermare la selezione con il pulsante <b>SAVE</b>. La modifica è possibile solo a dispositivo spento.</p>	<p>Impostare il livello di fiamma al quale il caminetto dovrà iniziare a funzionare. Fare clic su <b>SAVE</b> per salvare le modifiche. <b>RESET</b> per ripristinare le impostazioni. L'impostazione di fabbrica della fiamma è al livello</p>	<p>Controlla i caminetti disponibili. Fare clic su <b>EDIT</b> per modificare il nome del dispositivo. Fare clic su <b>CONNECT</b> per connettersi al dispositivo.</p>	<p>Contattare Planika via e-mail. Fare clic su <b>SEND</b> er inviare il messaggio.</p>

## MESSAGGI DI ALLARME

Help	Error	File a Report
		
<p>Fare clic su <b>HELP</b> nel MENU principale per andare alla scheda Risoluzione dei problemi</p>	<p>Intraprendere l'azione per eliminare il guasto. Se l'errore persiste, segnala il problema facendo clic su <b>REPORT</b>.</p>	<p>Se hai ancora bisogno di aiuto dal servizio, invia un messaggio con una descrizione del guasto e le informazioni di base facendo clic su <b>SEND</b>.</p>

## SEGNALI INFORMATIVI

DIODO DI ALIMENTAZIONE	DIODO DI AVVIO/ARRESTO	SUONO	AZIONE	COMUNICAZIONE
		-	Lampo verde	Dispositivo spento
		-	Verde lampeggiante	Il dispositivo è pronto a funzionare
		-	Verde lampeggiante	Procedura di avvio
		-		Funzionamento
		-	Lampeggiante blu	Assenza di carburante
		-	Lampeggiante blu	Rifornimento
			Lampeggio blu con suono	Serbatoio pieno
			Lampo rosso	Estrazione, raffreddamento
			Lampo viola con suono	Errore - controllare l'applicazione (risoluzione dei problemi) e contattare l'assistenza.
		-	Blu, rosso lampeggiante	Il serbatoio del carburante è vuoto durante il processo di combustione
DIODO WI-FI		AZIONE		COMUNICAZIONE
				Lampeggio blu
				Blu lampeggiante
				Verde lampeggiante
				Non connesso al wi-fi
				Accoppiamento / configurazione
				Wi-fi connesso

**BUSTIBILE** - Utilizzare solo il combustibile a base di etanolo prodotto dalle piante nel processo di distillazione dell'alcool a due tempi che consiste nel 95-96,6% di etanolo in volume. Fanola è il combustibile raccomandato con purezza farmacologica.

**NON USARE COMBUSTIBILI SINTETICI A BASE DI PETROLIO PERCHÉ SONO CONTAMINATI, EMETTONO ODORI SGRADUEVOLI E POSSONO DANNEGGIARE IL CAMINETTO! NON UTILIZZARE COMBUSTIBILI CONTENENTI IL 100%, GEL O COMBUSTIBILI AROMATICI!**

**PULIZIA** – Pulire con un panno umido e detersivi delicati quando il dispositivo è spento e freddo.

**SERVIS** – Conservare il cavo USB incluso per la manutenzione. Contatto e-mail [service@planikafires.com](mailto:service@planikafires.com)

## WYMIANA ZBIORNIKA PALIWA

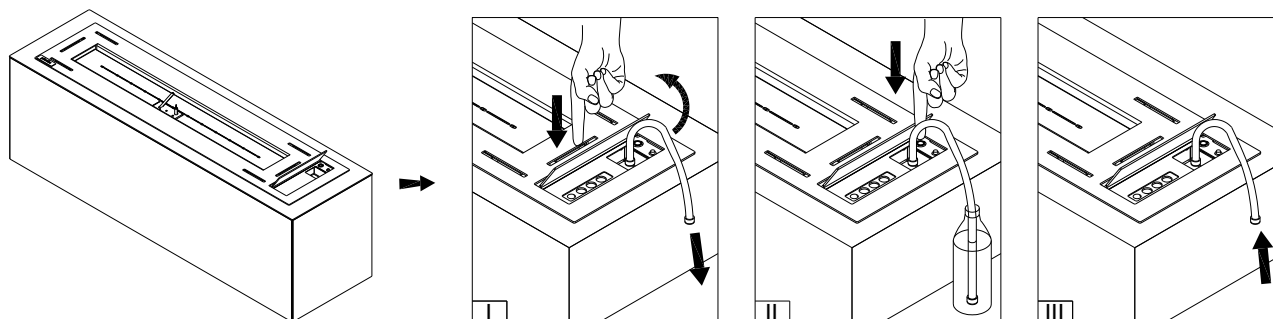

1. Włącz urządzenie, naciskając przycisk .
2. Jeśli zbiornik paliwa jest pusty (**NIEBIESKI PRZYCISK START/STOP ŚWIECI SIĘ**), otwórz klapkę i wyciągnij przewód paliwowy (I). Umieść luźny koniec w zbiorniku paliwa, a następnie naciśnij i przytrzymaj przycisk pompy paliwa (II).
3. Jeśli zbiornik paliwa napełni się (**ZIELONY PRZYCISK START/STOP ZAŚWIECI SIĘ**), włóż przewód paliwowy z powrotem na miejsce. (III)



## ODPALANIE PŁOMIENIA

Przycisk **START / STOP** podświetlony na zielono oznacza, że urządzenie jest gotowe do odpalenia płomienia. Wciśnij **START**. Odpalenie płomienia trwa 2-10 minut (**MRUGAJĄCA ZIELONA DIODA**). W tym czasie może być wyczuwalny zapach oparów paliwa. Gasnące diody informują, że płomień został odpalony i urządzenie osiągnęło temperaturę roboczą.

## REGULACJA WYSOKOŚCI PŁOMIENIA

Gdy płomień jest odpalony, wciśnij  lub  na pilocie lub przesunij pasek wysokości płomienia w aplikacji, aby zwiększyć lub zmniejszyć jego wysokość w 6 poziomach. Płomień domyślnie odpala się na 4. poziomie wysokości. **UWAGA!** W przypadku zbyt wysokiej temperatury urządzenia, wysokość płomienia zostanie automatycznie zmniejszona, a możliwość jej regulacji zablokowana. Jeżeli temperatura będzie nadal wzrastać, płomień zostanie wygaszony (**CZERWONA DIODA**)

## WYGASZANIE PŁOMIENIA

Aby wygasić płomień:

- wciśnij **STOP**.

**Mrugająca czerwona dioda** oznacza, że urządzenie jest schładzane. Ponowne odpalenie płomienia możliwe jest dopiero po wychłodzeniu urządzenia (**ZIELONA DIODA**).

## WYŁĄCZANIE URZĄDZENIA

Aby całkowicie wyłączyć urządzenie wciśnij .

Urządzenie wyłączy się automatycznie w przypadku wykrycia nieprawidłowości w pracy (sprawdź błąd w aplikacji).

## KONFIGURACJA ŁĄCZNOŚCI BEZPRZEWODOWEJ

Parowanie urządzenia z aplikacją odbywa się następująco (jednocześnie można parować tylko jedno urządzenie):

<p><b>Join the newsletter</b></p>		<p><b>Find your fireplace</b></p>	
<p>1. Włącz aplikację <b>FLA3 NET-ZERO</b> na telefonie. Potwierdź chęć przystąpienia do newslettera wpisując adres e-mail i klikając <b>SIGN UP</b> lub pomiń etap klikając <b>SKIP</b></p> <p>Google play      Appstore</p> 		<p>2. Na ekranie <b>FIND YOUR FIREPLACE</b> kliknij <b>CONNECT</b> aby rozpocząć wyszukiwanie sieci</p>	

3. Wciśnij i przytrzymaj przycisk **WIFI**  na kominku. Mruganie przycisku oznacza gotowość kominka do parowania. W przypadku braku aktywności gotowość zostanie anulowana po 5 minutach.

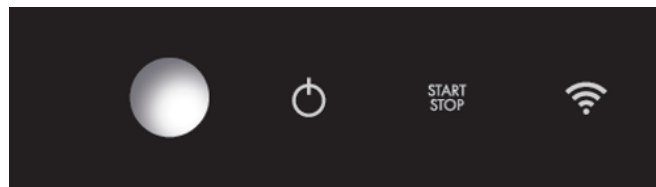

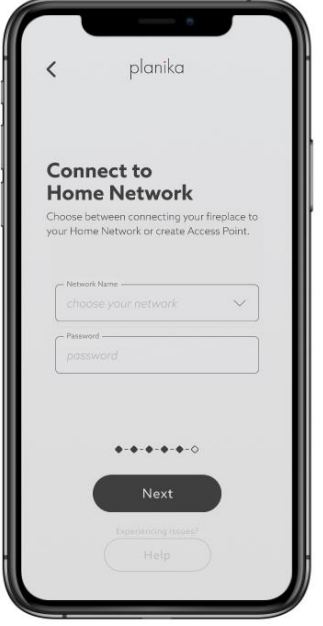
<p><b>Setup Network Active</b></p>		<p><b>Connect to Home Network</b></p>	
<p>4. Przejdź do ustawień urządzenia mobilnego, włącz sieć WiFi i połącz się z siecią <b>Fireplace_WiFi_setup</b> (jeżeli sieć nie jest widoczna, odłącz zasilanie urządzenia FLA na 10 sekund i powtórz konfigurację). Kominek zostanie automatycznie wyszukany przez aplikację. Potwierdzi to komunikat <b>SETUP NETWORK ACTIVE</b>. Kliknij <b>CONNECT</b>.</p>		<p>5. Na ekranie <b>CONNECT TO HOME NETWORK</b> wybierz nazwę sieci, którą chcesz docelowo używać (<b>NETWORK NAME</b>) oraz wprowadź jej hasło. Upewnij się, że hasło jest prawidłowe i kliknij (<b>SUBMIT</b>).</p>	



Your fireplaces		Access Point	
<p>6. Na następnym ekranie <b>YOUR FIREPLACES</b>, wybierz interesujące Cię urządzenie i kliknij <b>CONNECT</b>. Na tym ekranie dostosujesz też nazwę kominka klikając <b>EDIT</b>.</p>		<p>7. Jeżeli nie chcesz używać żadnej z dostępnych sieci, możesz stworzyć dedykowaną sieć <b>ACCESS POINT</b> i łączyć się z urządzeniem bezpośrednio. Aby to zrobić kliknij <b>(HELP)</b>, wybierz <b>(CONNECTION TYPE)</b> a następnie <b>(ACCESS POINT)</b> zatwierdzając kliknięciem w <b>(CREATE ACCESS POINT)</b>. Wprowadź nazwę sieci oraz hasło, potwierdź klikając <b>NEXT</b></p>	

Po udanej konfiguracji dioda WIFI będzie świecić się na zielono

### APLIKACJA FLA3 NET-ZERO



	<ol style="list-style-type: none"> <li>1. Newsletter</li> <li>2. Tryb kominka</li> <li>3. Wysokość płomienia</li> <li>4. Wygaszenie i odpalenie</li> <li>5. Info</li> <li>6. Menu</li> </ol>
---	--

## MENU

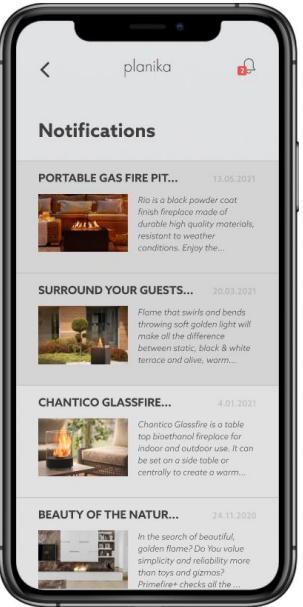

Menu jest dostępne po kliknięciu w ikonę . Powrót do głównego panelu jest możliwy po kliknięciu **WSTECZ** 

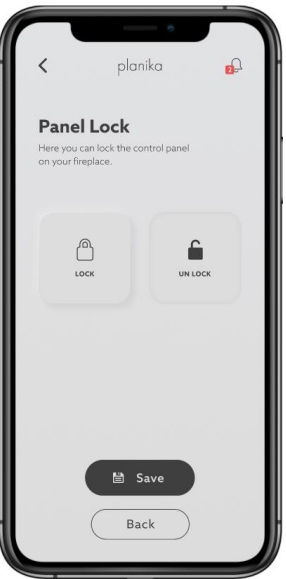
W celu uzyskania informacji ogólnych o kominku kliknij ikonę . Newsletter dostępny jest po kliknięciu w ikonę 

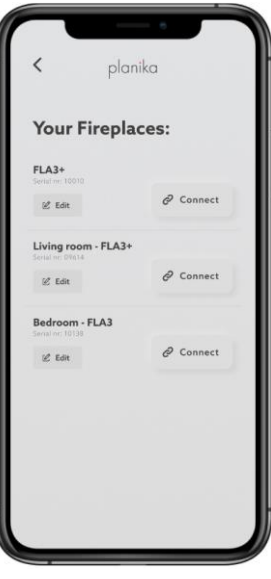
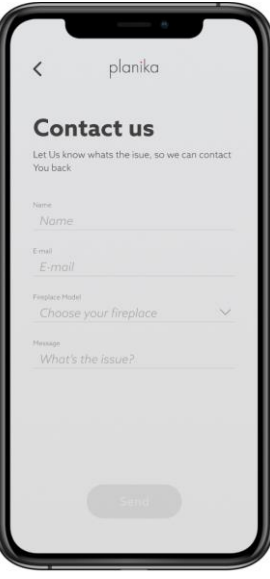



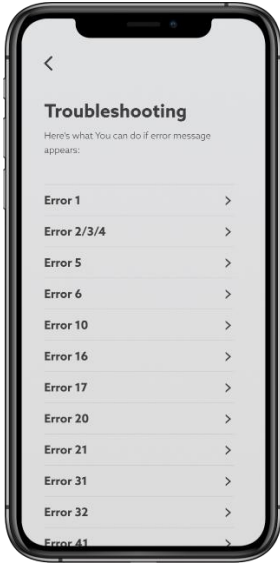

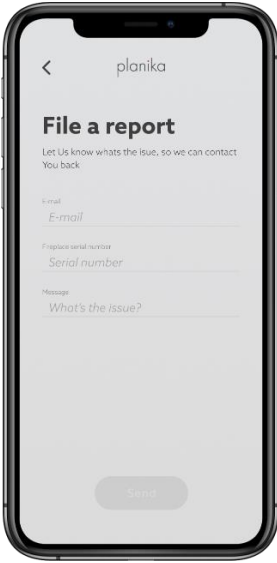





Menu	Info	Newsletter
		
<p>Główne ustawienia aplikacji. Kliknij w zakładkę w celu zmiany ustawień.</p>	<p>Kliknij aby sprawdzić podstawowe informacje o kominku.</p>	<p>Kliknij aby sprawdzić powiadomienia.</p>

Panel Lock	Default Level	Your fireplaces	Contact Us
			
<p>Kliknij <b>LOCK</b> aby zablokować panel sterowania na kominku. Kliknij <b>UNLOCK</b> aby odblokować panel sterowania na kominku. Wybór potwierdź przyciskiem <b>SAVE</b>. Zmiana jest możliwa tylko na zgaszonym urządzeniu.</p>	<p>Ustaw poziom płomienia, na którym kominek rozpocznie pracę po jego włączeniu. Kliknij <b>SAVE</b> aby zapisać zmiany. <b>RESET</b> aby zresetować ustawienia. Płomień fabrycznie jest ustawiony na poziomie 4.</p>	<p>Sprawdź dostępne kominki. Kliknij <b>EDIT</b> aby edytować nazwę urządzenia. Kliknij <b>CONNECT</b> w celu połączenia się z urządzeniem.</p>	<p>Skontaktuj się z Planiką poprzez wiadomość e-mail. Kliknij <b>SEND</b> aby wysłać wiadomość.</p>

## KOMUNIKATY ALARMOWE

Help	Error	File a Report
		
<p>Kliknij <b>HELP</b> w głównym <b>MENU</b> aby przejść do zakładki Troubleshooting.</p>	<p>Wykonaj działanie dotyczące danej usterki. Jeśli error nadal się pojawia zgłoś sprawę klikając <b>REPORT</b>.</p>	<p>Jeśli nadal potrzebujesz pomocy serwisu, wyślij wiadomość z opisem usterki oraz podstawowymi informacjami klikając <b>SEND</b>.</p>

## SYGNAŁY INFORMACYJNE

DIODA POWER	DIODA START/STOP	DŹWIEK	SYGNAŁ	KOMUNIKAT
		-	Zielony świeci	Urządzenie wyłączone
		-	Zielony świeci	Urządzenie gotowe do pracy
		-	Zielony mruga	Procedura odpalania
		-		Working
		-	Niebieski świeci	Brak paliwa
		-	Niebieski mruga	Tankowanie
			Niebieski mruga z dźwiękiem	Pełny zbiornik
			Czerwony świeci	Wygaszanie, chłodzenie
			Fioletowy świeci z dźwiękiem	Error – Sprawdź app (troubleshooting) i skontaktuj się z serwisem
		-	Niebieski i czerwony mruga	Zbiornik paliwa jest pusty podczas palenia
DIODA WI-FI		SYGNAŁ		KOMUNIKAT
				Niebieski świeci
				Niebieski mruga
				Zielony świeci
				Nie podłączony do wi-fi
				Parowanie / konfigurowanie
				Wi-fi połączone

**PALIWO** - Należy stosować wyłącznie paliwa etanolowego, powstałego z roślin w procesie dwukrotnej destylacji alkoholu składającego się z 95-96,6% objętości etanolu. Zalecany paliwem o czystości farmakologicznej jest Fanola. **NIE NALEŻY UŻYWAĆ SYNTETYCZNYCH PALIW NA BAZIE ROPY NAFTOWEJ, PONIEWAŻ SĄ ONE ZANIECZYSZCZONE, WYDZIELAJĄ NIEPRZYJEMNE ZAPACHY I MOGĄ USZKODZIĆ KOMINEK! NIE NALEŻY UŻYWAĆ PALIW ZAWIERAJĄCYCH OBJĘTOŚCIOWO 100% ETANOLU, PALIWA ŻELOWEGO LUB AROMATYZOWANEGO!**

**CZYSZCZENIE** – Czyść wilgotną szmatką i delikatnymi środkami, gdy urządzenie jest wyłączone i chłodne.

**SERWIS** – Zachowaj dołączony przewód USB do celów serwisowych. Kontakt mailowy [service@planikafires.com](mailto:service@planikafires.com)

## НАПОЛНЕНИЕ УСТРОЙСТВА ТОПЛИВОМ

1. Включите устройство, нажав .
2. Если топливный бак пуст (**ГОРИТ СИНЯЯ ЛАМПОЧКА START/STOP BUTTON**), откройте заслонку и вытащите топливный шланг (I). Поместите свободный конец в емкость для топлива, нажмите и удерживайте кнопку топливного насоса (II).
3. Если бак наполнился (**ГОРИТ ЗЕЛЕНЫЙ СВЕТ КНОПКИ СТАРТ/СТОП**), установите топливный шланг на место. (III)

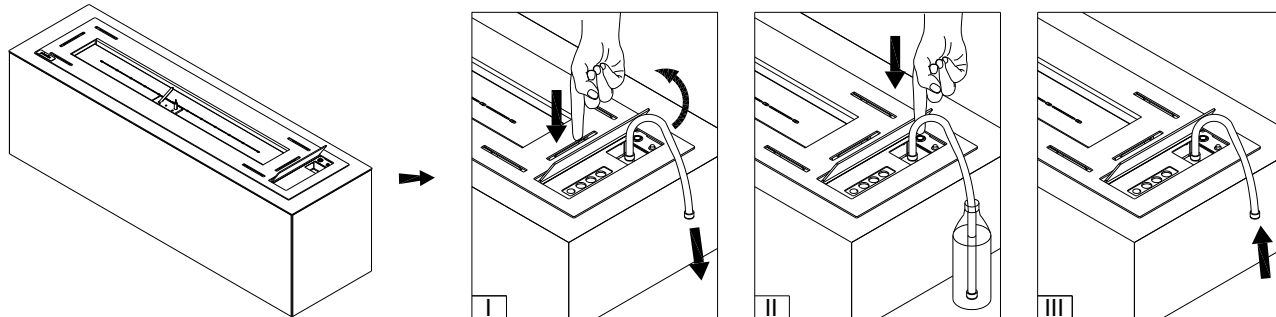



## ЗАПУСК КАМИНА

Зеленая подсветка кнопки **START / STOP** означает, что устройство готово к розжигу пламени.

Нажмите **START**. Для розжига пламени потребуется около 2-10 минут (**МИГАЮЩИЙ ЗЕЛЕНЫЙ СВЕТОДИОД**). На протяжении этого времени вы можете почувствовать запах паров топлива. Угасающие светодиоды информируют о возгорании пламени и о достижении устройством рабочей температуры.

## РЕГУЛИРОВАНИЕ РАЗМЕРА ПЛАМЕНИ

Когда пламя горит, нажмите  или  на пульте дистанционного управления либо переместить планку высоты пламени в приложении, чтобы увеличить или уменьшить его высоту на 6 уровнях. По умолчанию пламя разгорается на 4-й высоте.

**ВНИМАНИЕ!** Если температура устройства слишком высокая, высота пламени будет автоматически уменьшена, и ее регулировка будет заблокирована. Если температура продолжит расти, пламя погаснет (**КРАСНЫЙ светодиод**).

## ГАШЕНИЕ ПЛАМЕНИ

Чтобы погасить пламя:

нажмите **STOP**.

**Мигающий красный светодиод** означает, что устройство остывает. Повторное зажигание пламени возможно только после того, как устройство остынет (**ЗЕЛЕНЫЙ светодиод**).

## ВЫКЛЮЧЕНИЕ УСТРОЙСТВА





Чтобы полностью выключить устройство, нажмите кнопку .

Устройство автоматически выключится в случае сбоев в работе (проверьте ошибку в приложении.).

## БЕСПРОВОДНАЯ КОНФИГУРАЦИЯ

Устройство сопрягается с приложением следующим образом (одновременно может быть сопряжено только одно устройство):

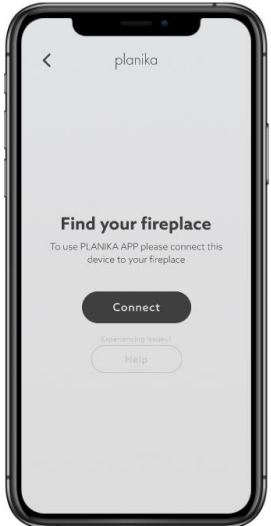

<p align="center"><b>Join the newsletter</b></p> <p>1. Запустите приложения <b>FLA3 NET-ZERO</b> в телефоне. Подтвердите свое желание подписаться на рассылку новостей, введя свой адрес электронной почты и нажав <b>SIGN UP</b> или пропустите шаг, нажав <b>SKIP</b></p> <p align="center">   </p> <p align="center">   </p>		<p align="center"><b>Find your fireplace</b></p> <p>2. На экране <b>FIND YOUR FIREPLACE</b> нажмите <b>CONNECT</b> чтобы начать ПОИСК СЕТИ.</p>	
---	--	---	--

3. Нажмите и удерживайте кнопку WiFi  на камине. Мигание кнопки означает, что камин готов к сопряжению. В случае бездействия режим ожидания будет отменен через 5 минут.

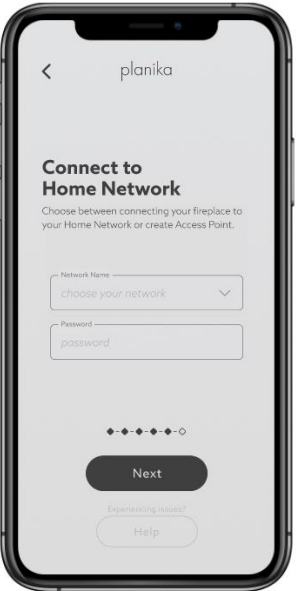

<p align="center"><b>Setup Network Active</b></p> <p>4. Зайдите в настройки мобильного устройства, включите сеть WiFi и подключиться к сети <b>Fireplace_WiFi_setup</b> (если сеть не видна, отключите устройство FLA от питания на 10 секунд и повторите настройку). Камин будет автоматически найден приложением. Это будет подтверждено сообщением <b>SETUP NETWORK ACTIVE</b>. Нажмите <b>CONNECT</b>.</p>		<p align="center"><b>Connect to Home Network</b></p> <p>5. На экране <b>CONNECT TO HOME NETWORK</b> выберите имя сети, которую вы хотите использовать <b>(NETWORK NAME)</b> и введите ее пароль. Убедитесь, что пароль правильный, и нажмите <b>(SUBMIT)</b>.</p>	
--	--	---	--





Your fireplaces		Access Point	
<p>6. На экране в закладке <b>YOUR FIREPLACES</b>, выберите интересующее вас устройство и нажмите <b>CONNECT</b>. На этом экране вы также можете изменить имя камина, нажав <b>EDIT</b>.</p>		<p>7. Если вы не хотите использовать ни одной из доступных сетей, вы можете создать определённую сеть <b>ACCESS POINT</b> и подключаться к устройству напрямую. Для этого нажмите <b>(HELP)</b>, выберите <b>(CONNECTION TYPE)</b>, а потом <b>(ACCESS POINT)</b> для подтверждения нажмите <b>(CREATE ACCESS POINT)</b>. Введите имя сети и пароль и подтвердите, нажав <b>NEXT</b></p>	

После успешной настройки индикатор WiFi будет светиться зеленым цветом.



### ПРИЛОЖЕНИЕ FLA3 NET-ZERO

	<ol style="list-style-type: none"> <li>1. Newsletter</li> <li>2. Режим камина</li> <li>3. Высота пламени.</li> <li>4. Тушение и разжигание</li> <li>5. Информация</li> <li>6. Меню</li> </ol>
---	---

## МЕНЮ

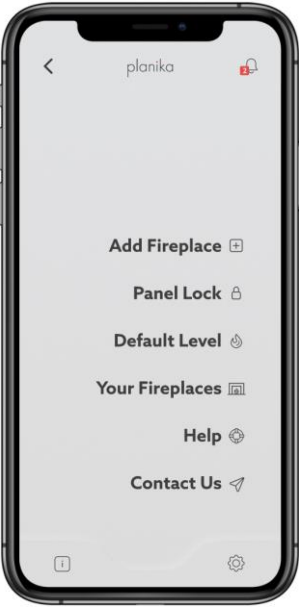
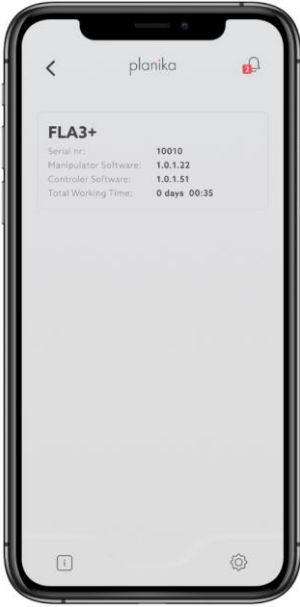
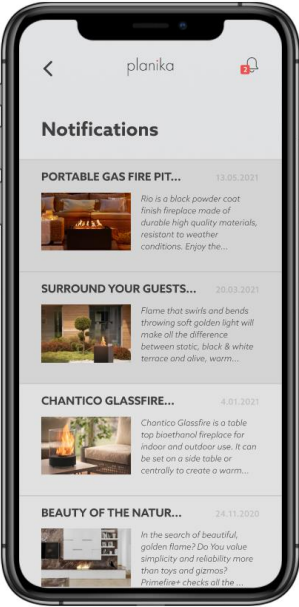
Меню доступно после нажатия на значок . Возврат на главную панель возможен с помощью нажатия значка **НАЗАД** . Для получения общей информации о камине щелкните значок . Newsletter будет доступен после нажатия на значок .

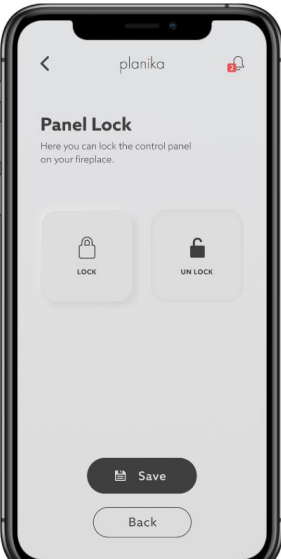
Menu	Info	Newsletter
		
<p>Основные настройки приложения. Нажмите на вкладку, чтобы изменить настройки.</p>	<p>Нажмите здесь, чтобы просмотреть основную информацию о камине.</p>	<p>Нажмите здесь, чтобы проверить уведомления.</p>

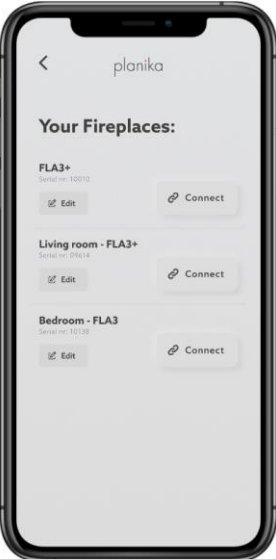
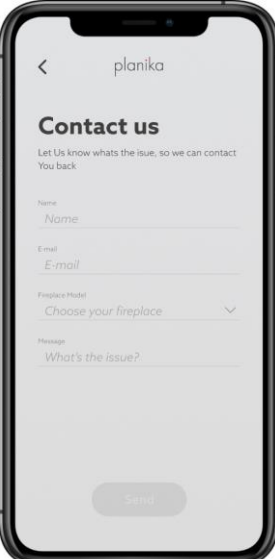
Panel Lock	Default Level	Your fireplaces	Contact Us
			
<p>Нажмите <b>LOCK</b> чтобы заблокировать панель управления на камине. Нажмите <b>UNLOCK</b> для разблокирования панели управления камином. Подтвердите свой выбор кнопкой <b>SAVE</b>. Изменение возможно только тогда, когда камин выключен.</p>	<p>Установите уровень пламени, при котором камин начнет работать при его включении. Нажмите <b>SAVE</b> чтобы сохранить изменения. <b>RESET</b> чтобы сбросить настройки. Заводская установка высоты пламени при включении камина на 4-ом уровне.</p>	<p>Проверьте доступные камины. Нажмите <b>EDIT</b> чтобы редактировать имя устройства. Нажмите <b>CONNECT</b> для подключения к устройству.</p>	<p>Свяжитесь с Planika по электронной почте. Нажмите <b>SEND</b> для отправки сообщения.</p>

## СООБЩЕНИЯ О ОШИБКАХ

Help	Error	File a Report
		
<p>Нажмите <b>HELP</b> в главном меню <b>MENU</b> чтобы перейти к вкладке Troubleshooting.</p>	<p>Следуйте инструкции по устранению данной ошибки. Если ошибка повторится, сообщите о проблеме, нажав <b>REPORT</b>.</p>	<p>Если вам все еще нужна помощь службы поддержки, отправьте сообщение с описанием неисправности и основной информацией, нажав <b>SEND</b>.</p>

## ИНФОРМАЦИОННЫЕ СИГНАЛЫ

ДИОД ПИТАНИЯ	ДИОД ЗАПУСКА/ОСТАНОВКИ	ЗВУК	ДЕЙСТВИЕ	КОММУНИКАЦИЯ
		-	Зеленый свет	Устройство выключено
		-	Зеленый свет	Устройство готово к работе
		-	Зеленый мигающий	Процедура запуска
		-		Работает
		-	Синий свет	Нет топлива
		-	Синее мигание	Заправка
			Синее мигание со звуком	Полный бак
			Красный свет	Промывка, охлаждение
			Фиолетовый свет со звуком	Ошибка - проверьте приложение (устранение неисправностей) и обратитесь в сервисную службу
		-	Синее, красное мигание	Топливный бак пуст во время процесса горения
	<b>ДИОД WI-FI</b>		<b>ДЕЙСТВИЕ</b>	<b>КОММУНИКАЦИЯ</b>
			Синий свет	Не подключен к wi-fi
			Синее мигание	Сопряжение / конфигурация
			Зеленый свет	Wi-fi подключен

**ТОПЛИВО** - Использовать только этаноловое топливо, полученное из растений в процессе двукратной перегонки спирта, состоящее из 95-96,6% этанола по объему. Фанола является рекомендуемым топливом фармакологической чистоты.

НЕ ИСПОЛЬЗУЙТЕ СИНТЕТИЧЕСКОЕ ТОПЛИВО НА НЕФТЯНОЙ ОСНОВЕ, ТАК КАК ОНО ЗАГРЯЗНЕНО, ИЗДАЕТ НЕПРИЯТНЫЙ ЗАПАХ И МОЖЕТ ПОВРЕДИТЬ КАМИН! НЕ ИСПОЛЬЗУЙТЕ ТОПЛИВО, СОДЕРЖАЩЕЕ 100% ЭТАНОЛА ПО ОБЪЕМУ, ГЕЛЬ ИЛИ АРОМАТИЧЕСКОЕ ТОПЛИВО!

**ЧИСТКА** – Для чистки использовать мягкий материал и нежные чистящие средства, когда устройство не работает и охлаждено.

**СЕРВИСНОЕ ОБСЛУЖИВАНИЕ** – Сохраните прилагаемый USB-кабель для обслуживания. Адрес электронной почты для контакта со службой поддержки [service@planikafires.com](mailto:service@planikafires.com)